



Agilent Modular Products

M9392A PXI Vector Signal Analyzer

Multichannel Wideband Streaming White Paper

Abstract

The Agilent M9392A PXI Microwave Vector Signal Analyzer, together with the hardware and software configurations described in this white paper, provide a streaming and recording capability on two or more synchronized channels of 100 MHz wideband RF environment. The white paper provides detailed step-by-step instructions for creating a streaming solution including:

- Hardware configurations
- Software applications
- 89600 VSA software for data analysis
- Demonstration example for setting up multichannel streaming



Introduction

Engineers face the challenges of making RF or uW measurements in noisy environments and analyzing significant amounts of measurement data to determine its causes. An application note titled *Agilent Modular Products M9392A PXI Vector Signal Analyzer System with Streaming Capability* (literature number 5990-8872EN) outlines a test methodology and hardware and software configurations to stream and capture data to perform specific analyses to determine the causes of RF interference.

This white paper provides detailed step-by-step instructions and a demonstration example to enable engineers to create a multichannel 100 MHz wideband signal analyzer streaming solution. Streaming is a generic term that is used to identify real-time throughput of data into a device or out of a device. This document covers the use of an RF receiver to stream data to final storage (or RAM). Though it is possible to playback data real-time from an RF source, this topic is not covered in this document. In this paper, data playback is achieved through the following software applications used to read and playback a previously stored recording:

- Agilent 89600 VSA software
- X-Com Systems Spectro-X and Dataviewer

This paper also describes ways to make “gapless recordings” of streamed data from a receiver to final storage, single hard disk or RAID so that no data meeting measurement requirements will be lost.

Challenge the Boundaries of Test ...

... Agilent Modular Products





Applications

The 2-channel PXI Vector Signal Analyzer (VSA) based on the Agilent M9392A provides the flexibility required for general RF testing. The 100 MHz bandwidth on two channels is useful for field testing on the latest RF devices.

RF interference testing is a primary application for the 2-channel VSA, as it is easy to configure a measurement that records data on two adjacent channels. Targeted streaming acquisitions can be made on a second digitizer based on data from the primary digitizer in continuous normal acquisition mode. The recording session on the second digitizer is triggered after a conditional analysis of data on the other channel.

The solution described proposed in this document is superior to traditional methods used to determine the causes of RF interference. It maximizes the possibility of recording the “target event” and reduces time spent analyzing data.

Please refer to the following documents which provide information about streaming applications:

- *Interference Detection in Wireless Devices* (literature no. 5990-9965EN)
- *Single Channel Streaming with the M9392A* (literature no. 5990-8872EN)
- *Configuring the JMR RAID with the M9392A* (literature no. 5990-9483EN)

Table of Contents

	Page
1. Software Installation Instructions	4
2. Hardware Configurations	5
<i>M9202A trigger setups, 2-channel streaming, 4 channel streaming, M9300 reference, timing, synchronization and GPS positioning, and RAID storage</i>	
3. Applications with the M9300A	14
4. Applications with Symmetricom Timing, Synchronization and GPS Positioning Card	16
5. Using the M9392A Soft Front Panel to Set Up Multichannel Hardware Configurations	18
6. Data Analysis with 89600 VSA	18
<i>Dual M9392A/Dual digitizer only, new trigger delay and slave trigger input extensions and playback streaming waveforms on the 89600</i>	
7. Offsetting Digital Down Conversion (DDC) Frequencies	26
8. Multichannel Streaming Demonstration Example	28
9. Viewing and Analyzing Streaming Data	37
<i>DataViewer and Spectro-X Signal analysis software from X-Com Systems</i>	
10. API Programming Instructions	40
11. Appendix	41

Multichannel Wideband Streaming with PXI M9392A

1. Software Installation Instructions

This section lists the software required to control the various modules and provides step-by-step instructions for its installation.

The table below provides a list of software and the URL where the software can be downloaded.

For PXI LO, 2-channel M9392A, independent LO's

Software	Download location
M9018A chassis drivers	www.agilent.com/find/M9018A
Agilent IO Libs 16.1	http://www.home.agilent.com/agilent/product.jsp?cc=US&lc=eng&ckey=1985909&nid=-33330.977662.00&id=1985909&cmpid=zzfindiosuite
M9392A drivers, version 1.3.0	www.agilent.com/find/m9392a
M9381A drivers (M9300A Frequency Reference driver required, other module drivers optional). Choose custom installation in the M938x software installer.	www.agilent.com/find/m9381a
89600 VSA (Optional)	www.agilent.com/find/vsa
Multichannel streaming demonstration example	http://www.home.agilent.com/agilent/facet.jsp?t=80045.k.1&cc=US&lc=eng&sm=g Look for multichannel streaming example program

Install these software packages in the order listed, following prompts for reboot whenever requested.

After all software has been installed, reboot the system, and run Agilent Connection Expert to verify that all modules enumerate with a VISA resource ID, and that each module appears with the correct slot number identified on the information pane on the right when you click on each module.

The M9300A Frequency Reference module provides a 100 MHz clock to the M9202A digitizers when the M9302A Local Oscillator is not used.

2. Hardware Configurations

M9202A trigger setups

M9202A multichannel setups are synchronized via distribution of a trigger out from the master digitizer to the trigger input of all digitizers. Synchronization performance of the multichannel VSA is ± 2 samples of trigger uncertainty from acquisition to acquisition. This means the operation is not phase coherent but still adequate for MIMO PHY-layer EVM measurements. At full data rate, or 2 GSa/s, ± 2 samples of trigger uncertainty is based on the output sample rate. For example, at 100 MHz bandwidth (BW), 125 MSa/s is used, equating to a trigger uncertainty of ± 16 ns between channels which cannot be calibrated out.

There are three primary trigger modes: free run, IF magnitude, and external. The following table describes the conditions for which the various trigger modes are valid.

Mode	Single channel input	Multichannel input
Free run (software trigger)	Auto-trigger	Auto-trigger (unsynchronized acquisition)
IF magnitude	Master input 1	Master input 1
External	Master TRG 1	Master TRG 2

There is no software trigger mode synchronization for multichannel operation. Therefore, free run with a multichannel system will result in unsynchronized results. It is necessary to use either external or IF magnitude trigger modes for synchronized operation, which is required for multichannel streaming.

In IF magnitude trigger mode, the master digitizer triggers on the input signal into input 1 connector. It is an envelope edge trigger, and not a level trigger. The master digitizer outputs a trigger output pulse of amplitude approximately 0 to -1 V. This must be routed into all digitizers' TRG 1 inputs including the master digitizer's input.¹

In external trigger mode, the master digitizer triggers on the TRG 2 input. The master digitizer outputs a trigger output pulse of amplitude approximately 0 to -1 V. This must be routed into the slave digitizers' TRG 1 inputs. It is not necessary to route the signal into the master digitizer's TRG 1 input, but doing so will not impair performance. In both cases above, it is necessary to set the trigger input threshold for the TRG 1 input to a negative voltage around -0.5 V.

1. This mode is only available when using hardware DDC. In basic digitizer mode, only external trigger mode is available. When using the streaming capability the hardware DDC is also required. This means that the digitizer IF must be nominally set to 500 MHz IF but can be offset by some cardinal values which depend on which decimation stages have been used. For a bandwidth of 100 MHz the digitizer will be sampling at 125 MSa/s. In this case it is possible to offset the IF center frequency by ± 125 MSa/2 or 62.5 MHz. See Section 8, Offsetting Digitizer DDC Frequencies.

Also note that there will be some inherent delay between the master and slave digitizers, as well as an inherent delay from trigger arrival at the master to signal acquisition. Some effort is made in the software to correct for this since in master/slave trigger synchronized mode the master/slave delay is always less than ± 2 samples (at DDC sample rate) in multichannel streaming mode.

When streaming acquisitions are made, each channel recording has a separate header file which indicates the settings under which the recording was made. One of these settings, XStart records the time when the trigger event occurred.

The diagram at right shows the trigger connections for a 2-channel configuration. This setup will work for both IF magnitude and external trigger modes.

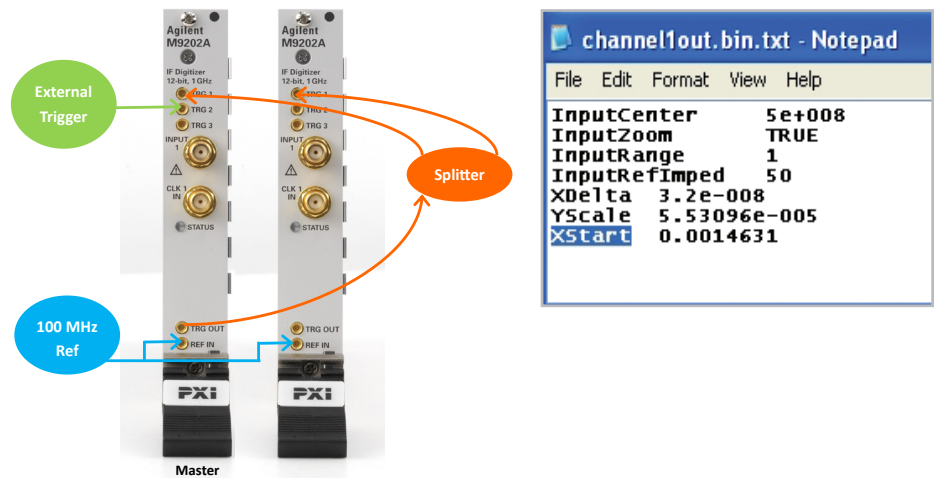

2-channel streaming with M9392A and M9302A PXI local oscillator or external local oscillator

A 2-channel streaming solution with independent local oscillator (LO) tuning provides the most flexibility for RF environment testing, as the 100 MHz streaming channels can be configured in various ways.^{1,2} Data can be recorded on two synchronized channels simultaneously at any frequency supported by the M9392A. In master/slave triggering mode, the acquisition on both channels can be synchronized to within ± 2 digitizer samples.

2-channel PXI local oscillator, independent local oscillators

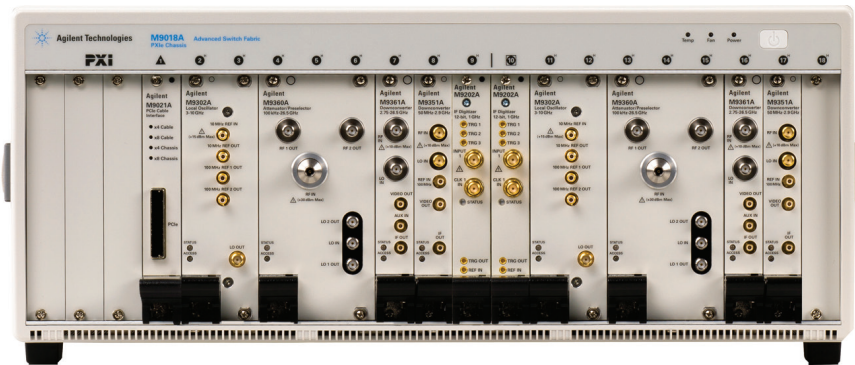

1. When using two M9392A Vector Signal Analyzers, 100 MHz streaming is only supported above 2.25 GHz since the M9351A RF Downconverter only supports 40 MHz bandwidth.
2. When using the M9360A preselector path in high band above 2.75 GHz the YIG tuned filter has a maximum bandwidth of 40 MHz.

2-channel block diagram, PXI LO, independent LO's

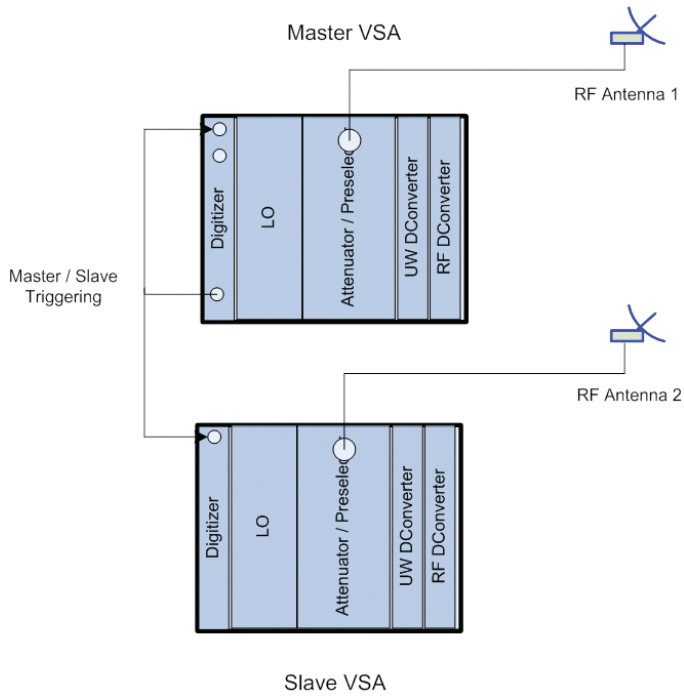

2-channel cabling, PXI LO, independent LO's

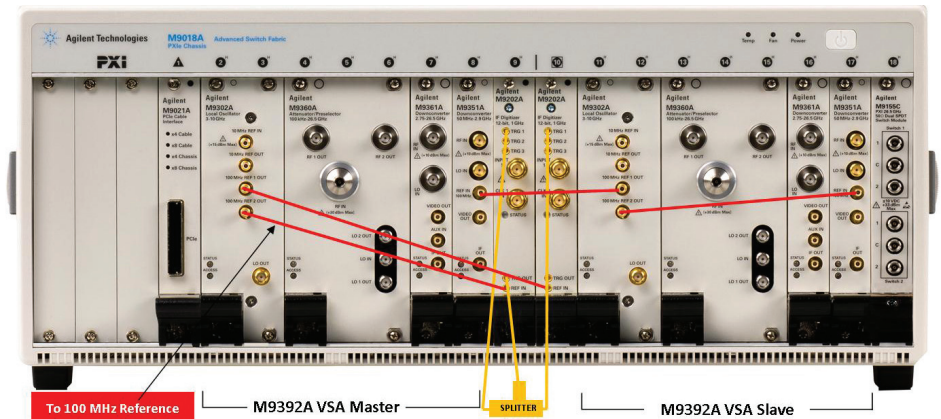

4-channel streaming: two chassis, each with two channels

The 89600 VSA software supports 4-channel configurations, but configurations of more than four channels can be created. 4 x 100 MHz simultaneous streaming channels can be created with two complete 2-channel VSA streaming solutions.

When using two or more chassis', it may be necessary to use two PCI express extender cards with a desktop controller to connect both chassis.

Software support for M9362A-D01, M9352A, M9168C and external LO

Support for M9362A-D01 4-channel downconverter, M9352A 4-channel IF amplifier/attenuator and the M9168C RF attenuator are included in v2.0 of the multichannel streaming example program. This hardware will be coupled to the M9202A + Other hardware configuration in the multichannel streaming example program. External LO support using an MXG has also been provided. A number of IVI configuration names will be loaded from an external configuration file.

Hardware configurations supported in v1.0 & v2.0 of the demonstration example described in Section 8

Hardware module/PC card	# of slots	Default IVI storage name	Function
M9392A analyzer configured as master trigger instrument	8	MasterVSA	uW vector signal analyzer
M9392A analyzer configured as a slave, to be triggered by the master	8	SlaveVSA	uW vector signal analyzer
M9392A digitizer only configured as master trigger instrument	1	MasterDigit	Digitizer only vector signal analyzer. User provides software control of RF HW
M9392A digitizer only configured as a slave, to be triggered by the master	1	SlaveVSA	Digitizer only vector signal analyzer. User provides software control of RF HW

Hardware configurations supported in v2.0

Hardware module/PC card	# of slots	Default IVI storage name	Function
M9168C 100 dB RF attenuator	2	RFAattenCh1	Channel 1 RF attenuation for M9362A-D01 quad
M9168C 100 dB RF attenuator	2	RFAattenCh2	Channel 2 RF attenuation for M9362A-D01 quad
M9362A-D01 quad downconverter	3	QuadDConv	4 channel RF downconverter
M9352A quad IF amp/atten	1	QuadIF	4 channel IF amp/atten
M9300A frequency reference	1	Ref	Replaces PXI LO when using an external LO
MXG (LO)	n/a	MXGLO	Provides LO for M9362A-D01

The additional hardware is required when using the M9202A + Other Hardware mode in the demonstration program. It is controlled by a text configuration file found in the program/bin folder. For clarity, the example shows the full PXI names for some of the external modules instead of the alias names.

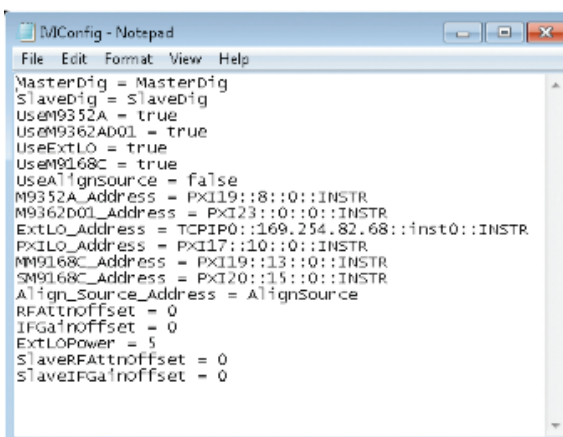

```

IVIConfig - Notepad
File Edit Format View Help
MasterDig = MasterDig
SlaveDig = SlaveDig
UseM9352A = true
UseM9362AD01 = true
UseExtLO = true
UseM9168C = true
UseAlignSource = false
M9352A_Address = PXI19::8::0::INSTR
M9362D01_Address = PXI23::0::0::INSTR
ExtLO_Address = TCPiP0::169.254.82.68::inst0::INSTR
PXILO_Address = PXI17::10::0::INSTR
M9168C_Address = PXI19::13::0::INSTR
SM9168C_Address = PXI20::15::0::INSTR
Align_Source_Address = AlignSource
RFAttnOffset = 0
IFGainOffset = 0
ExtLOPower = 5
SlaveRFAttnOffset = 0
SlaveIFGainOffset = 0
    
```

Hardware configurations being considered for future releases

Hardware module/PC card	# of slots	Default IVI storage name	Function
M9155C dual uW switch	1	uWSwitch1	Provides signal mux capability for preamp
Symmetricom bc637PCI-V2 IRIG/GPS	1 [PC slot]	SymTime	Adds time stamping
M9405A	1	PreAmp	26.5 GHz 30 dB preamp

Using these IVI configuration names for your own defaults will map to the default IVI configuration names in the example software.

For information on configuring a Wideband Multichannel System for MIMO Applications, please see literature no. 5991-0135EN.

Potential M9202A digitizer firmware upgrades

If upgrading an existing system for multichannel, the M9202A digitizer firmware needs to be at version 512 or greater. Documentation describing the upgrade process can be found in the M9392A help system. To check the firmware version number, use the soft front panels (SFP) for the MD1 or the M9392A. To check using the M9392A SFP, connect to the digitizer then select Help→About. On the about screen, the digitizer hardware FPGA version will be displayed. If a version less than 512 is displayed, follow the instructions in the M9392A documentation to upgrade to version 512. Check this for each digitizer in the configuration.

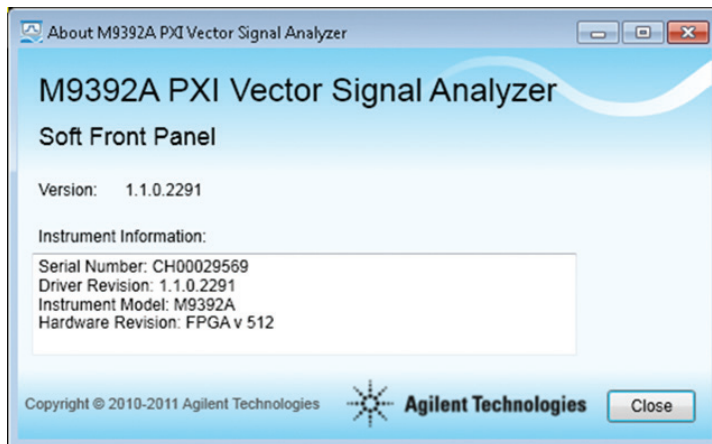

M9300A frequency reference

When an external LO is used, the M9300A is placed in the timing and synchronization slot 10 in an Agilent M9018A chassis. The M9300A is required to provide a 100 MHz clock for each of the M9202A digitizers. In a future software release this module will be enabled for trigger distribution to provide its own software issued trigger for cases when we would like to completely control M9392A acquisition.

The M9300A SFP can be used to enable the 100 MHz reference output, and configure 10 MHz reference input and output.

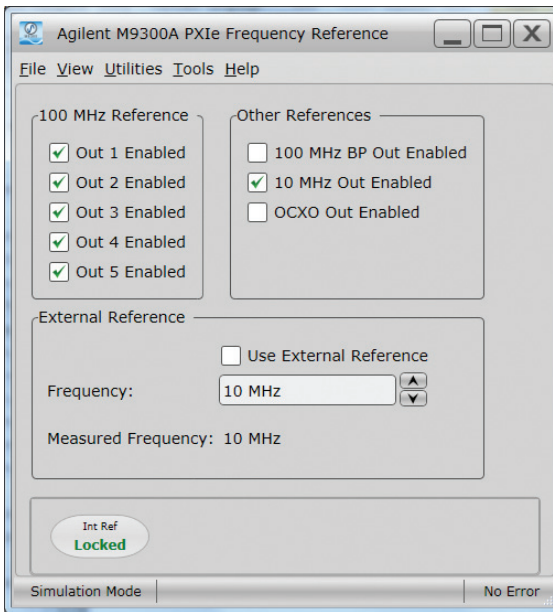



M9300A PXIe Frequency Reference

Using a software generated trigger to Initiate a streaming acquisition

The M9300A module can be used to issue a software trigger via the API. Any instrumentation used in the measurement system that can issue a software trigger under programmatic control can be used in this recording mode.

When issuing a software programmable trigger to start a streaming session the recording channel itself can be triggered from either an external trigger event or a signal magnitude threshold (video trigger).

An external trigger is connected to the Trg1 input. The magnitude trigger is generated in the DDC hardware chain beginning at the digitizer RF connector. Section 8 on Offsetting Digitizer DDC Frequencies provides more details.

An alternative hardware configuration is required (pictured below) when one channel is used to monitor data and the other is used to record data. In this configuration, a DC block is used to issue triggers to the second digitizer. The master digitizer is used to acquire data and issue a trigger to the second digitizer based on data analysis by the VSA 89600 SW. This configuration is not compatible with the other configurations described above. The DC block should be removed when operation does not require the master digitizer in normal acquisition mode to provide triggers to the second digitizer.

The term trigger digitizer is used here in the sense that the data acquired by this digitizer is used to conditionally trigger a recording on another channel by programming an instrument to generate the software controlled trigger. An Agilent signal source can be programmed to perform this task. In situations where a software controlled trigger is not available an M9300A reference module can be used.

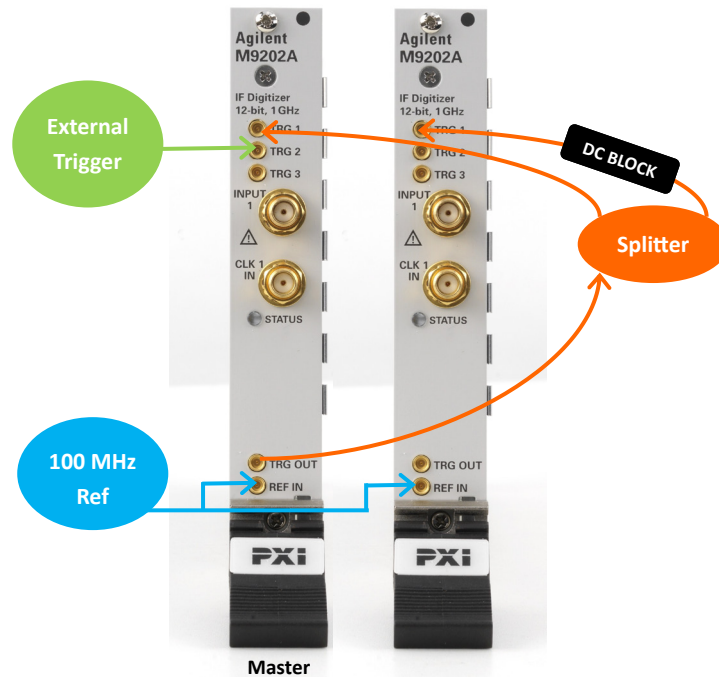

Timing, synchronization and GPS positioning

If an inter-range instrument group (IRIG)/GPS capability is required then a module, such as the Symmetricom model bc637PCI-V2 can be added to the Dell T5500 workstation. The Symmetricom time and frequency processor has a port that accepts triggers or other external events. In the case of a 2-channel streaming solution the trigger event that starts a recording can also be used to trigger this module to obtain accurate time and position information.

Symmetricom model bc637PCI-V2 module shown is a GPS synchronized, PCI time & frequency processor from Symmetricom Systems.

Precision Time & Frequency in the PCI Form Factor

Inputs

- GPS
- AM Time Codes
- DCLS Time Codes
- External Events (3x)
- 10 MHz
- 1PPS

Outputs

- AM Time Codes
- DCLS Time Codes
- Programmable Alarm (Strobe/Time Compare)
- <<1PPS to 100 MPPS rates
- 1PPS
- 1,5,10 MPPS
- Oscillator Control Voltage

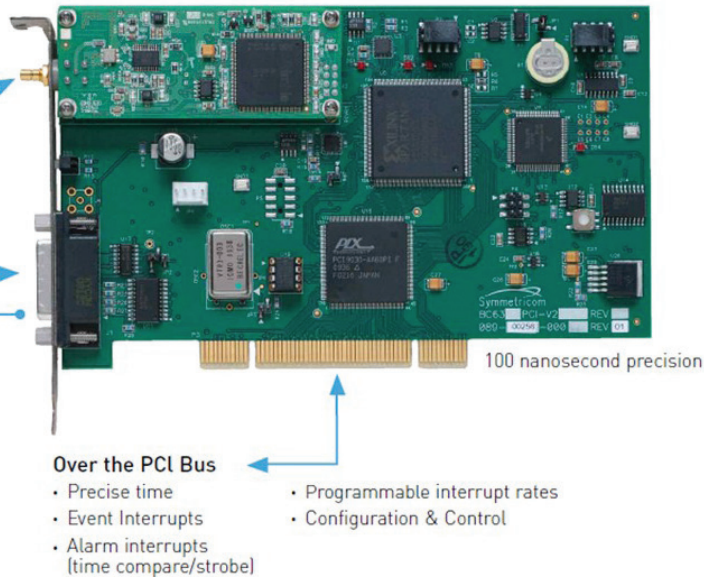

Over the PCI Bus

- Precise time
- Event Interrupts
- Alarm interrupts (time compare/strobe)
- Programmable interrupt rates
- Configuration & Control

RAID storage (optional)

RAID storage is required for any full bandwidth streaming captures of more than a few seconds. For narrow band captures greater than 10 MHz bandwidth and very long durations, a RAID is also recommended. At wider bandwidths data acquisition occurs at a much faster rate than can be moved to final storage, particularly if final storage is a single hard disk drive. The RAM allocated for the acquisition is filled up faster than it can write out to disk which presents a risk of losing or overwriting data.

Single channel streaming data flow

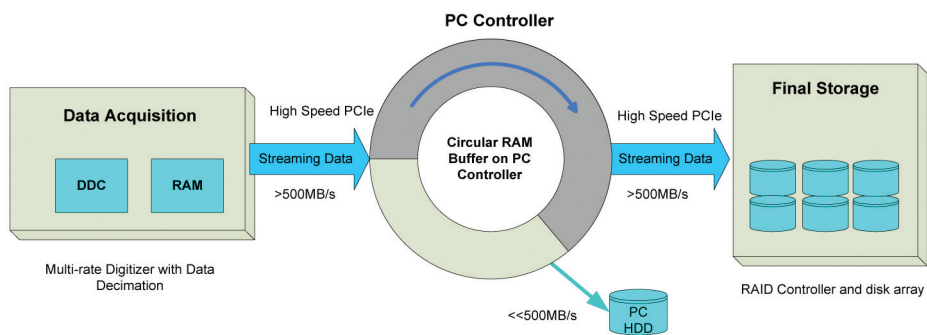

When a RAID is used to write out multiple streams of data, it is a good practice to write each stream out to a separate virtual drive, each with its own controller. This maximizes throughput of each stream because the data storage does not have to deal with any contention issues. Agilent references a number of pre-configured JMR RAID storage systems. When storing 2 x 100 MHz simultaneous streams the dual controller RAID system is recommended. Each internal controller has half of the available disk array allocated to it. This means that on a typical computer system (the Dell T5500 is recommended) one controller will appear as Volume E and the other as Volume F. Recommended dual channel controller JMR RAID options for this purpose are AGIL-4G-DC-16T and AGIL-4G-DC-32T.

The figure at right illustrates the data flow for a dual channel RAID controller. Each controller presents a unique volume to the user.

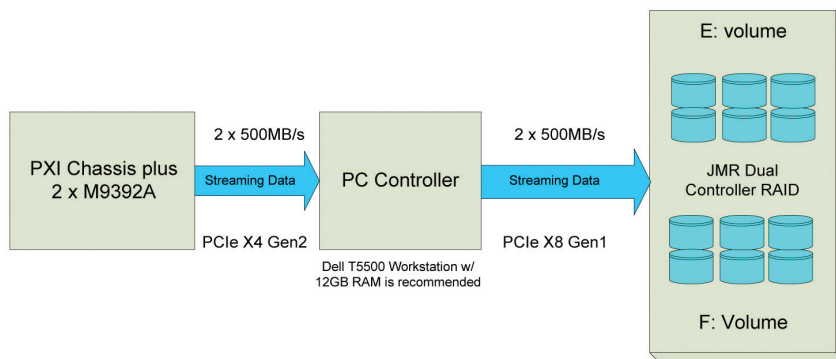

3. Applications with M9300A Frequency Reference Module

Having a flexible 2-channel system presents a number of interesting operating modes. In addition to fully synchronized 2-channel recordings, another useful feature of this system is to use one channel to trigger a recording on the second channel after performing analysis on the data from the RF environment. In cases where the engineer has narrowed down to a short list of intermittent interfering signals that could be affecting a new RF device, it is possible to acquire data normally on one channel, perform targeted analysis on this data and then decide based on an analysis of this data whether to trigger a recording on the other channel. The analysis does not have to be completed in real time, as the recording channel can be configured to acquire an exact amount of pre-triggered data. For example, if it takes two seconds to perform the required analysis on the trigger channel data, the recording channel can be setup to capture more than two seconds worth of pre-trigger data, so the event of interest will not be missed. This useful feature allows the engineer to go beyond simple frequency mask triggering. For each second of pre-trigger data at 100 MHz bandwidth, 500 MB of controller RAM will be required.

The figure at right illustrates how the signal analysis trigger mode works.

Pseudo-code for signal analysis trigger

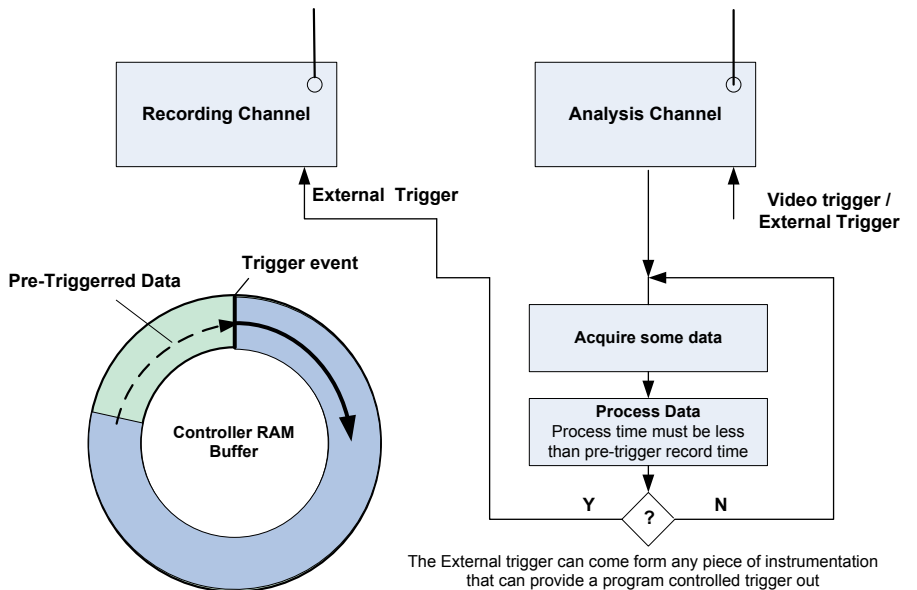

```

Loop (!exit)

    Acquire Data On Trigger Channel
    Analyze Trigger Channel Data
    Issue_Trigger (T/F)

    IF(!Recording && Issue_Trigger)
        Trigger Recording ?

    IF(Recording && Issue_Stop)
        Stop Recording? [Duration Unlimited Mode Only]

IF (Issue_Trigger)
    Set Recording Channel Trigger Mode
    Set Recording Channel Pre-trigger Time
    Set Streaming Mode [ Duration Limited or Duration
Unlimited]

    IF (Duration_Limited)
    {
        Set Recording Time
        Start Streaming For Recording Time
        Update Streaming Status [every 1 second]
    }

    IF (Duration Unlimited)
    {
        Start Streaming
        WHILE(!Stop_Recording)
            Update Streaming Status [every 1 second]

        Stop Recording
    }

End Loop

```

4. Applications with Symmetricom Timing, Synchronization & GPS Positioning Card

Using a Symmetricom IRIG/GPS timing card with a 2-channel M9392A streaming solution allows the engineer to trigger a recording and map the trigger point in the streaming data to an absolute time stamp and position coordinates. The diagram below illustrates how the trigger channel works with the digitizer in normal acquisition mode to search for specific data. Continuous acquisitions are made until a significant event is detected. The event can be a signal at a specific frequency or level or it can be a particular burst characteristic or communications standard. The data from the trigger channel is continuously monitored. Software, such as the 89600 VSA software, can analyze the data and determine whether the current data meets the required criteria. If the necessary criteria are met then the PC controller can be set up to issue an external trigger to begin a recording.

The software controlled trigger can be issued for a signal source, for the M9300A frequency reference or any other piece of hardware that can generate a trigger signal from a software event. In theory, it would be quite easy to create a long term data sampling system to acquire a few minutes' worth of streaming data to a RAID every few hours. For each streaming acquisition, a header file is created that describes and records when each trigger event occurred. The Symmetricom timing card could be configured to output a time stamp each time it received the same trigger to mark the absolute time for any of the streaming record samples.

In the figure below, a 10 minute streaming acquisition is made every three hours over a period about two weeks. This setup could be very useful for tracking telemetry data over long periods of time.

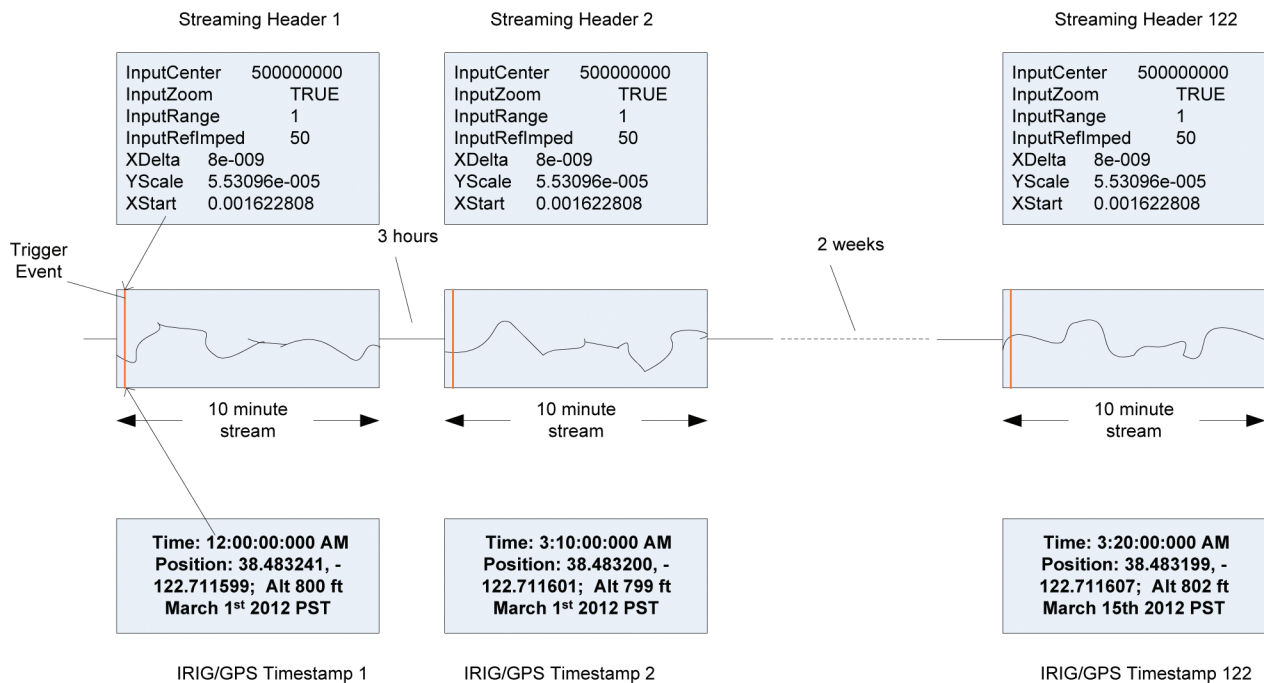

A more detailed view of streaming with IRIG/GPS time stamping. The figure below shows 2-channel M9392A with IRIG/GPS time stamping correlated to trigger time in the recording.

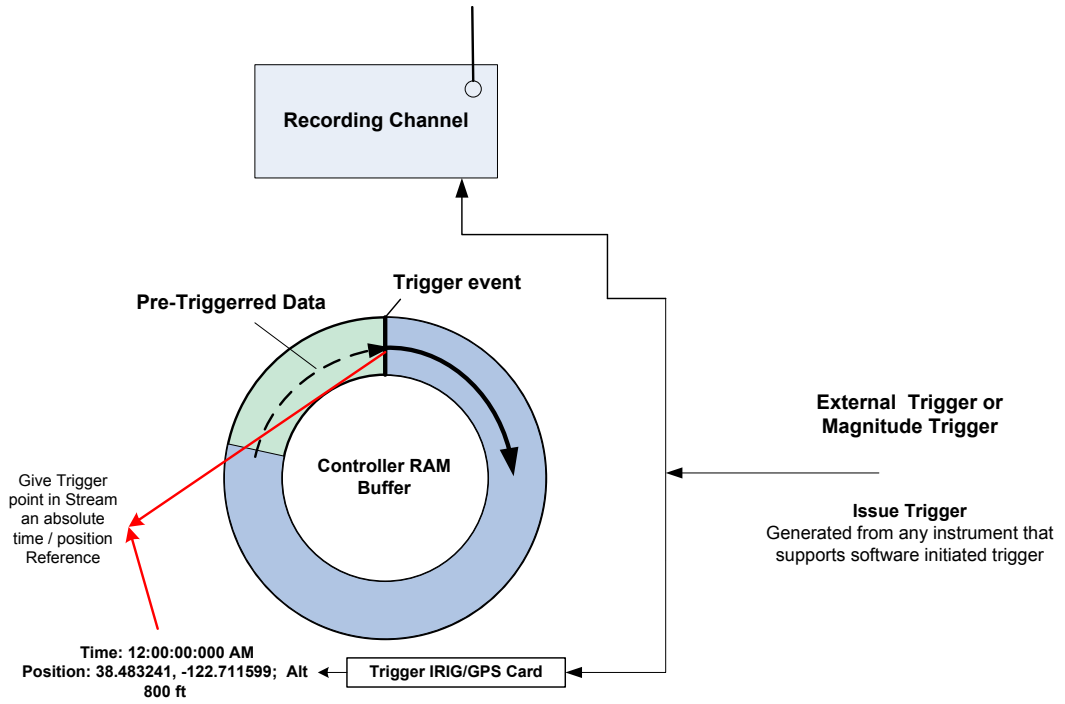

The trigger point in a streaming record is marked as the time from the start of the record. This time is marked by XStart from the header file

```

InputCenter 5e+009
InputZoom TRUE
InputRange 1
InputRefImped 50
XDelta 8e-009
Yscale 6.87132e-005
Xstart 1.388e-005 — Time in acquisition block
  
```

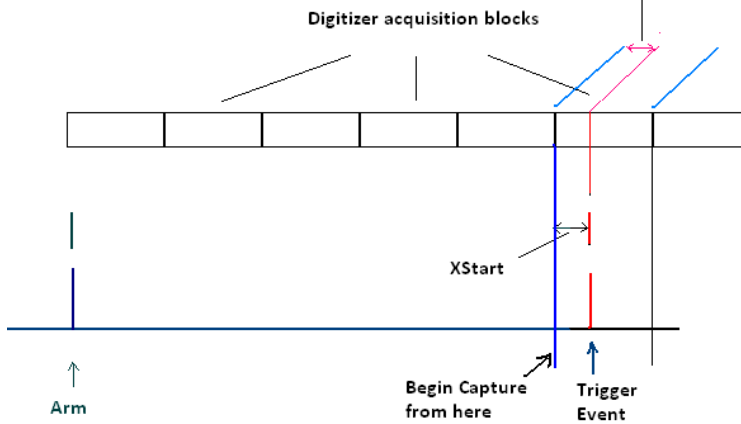

5. Using the M9392A SFP to Set Up Multichannel Hardware Configurations

This section covers the use of the M9392A Soft Front Panel (SFP) to control modules and create IVI configurations. Also included in this section, is an explanation of the M9392A streaming implementation, memory and final storage details. The SFP for the M9392A does not support multichannel streaming. However, the multichannel demonstration program adds multichannel support for the API including input extensions for the 89600 VSA software.

Please note that the M9392A API must be running on a 64 bit operating system to implement multichannel streaming. In a multichannel configuration, the M9392A SFP is used primarily to configure and control a complete M9392A signal analyzer or a single M9202A digitizer in digitizer only mode. It is used to create and export IVI configurations which can be programmatically accessed by other software, such as the multichannel streaming demonstration example program or the 89600 VSA software.

Please refer to the M9392A documentation for details on selecting modules and creating other configurations.

6. Data Analysis with 89600 VSA Software for Multichannel Streaming

This section covers configuring and using the 89600 VSA software to playback multichannel streaming records from the dual channel PXI vector signal analyzer (VSA). Please be aware that the streaming interface for the M9392A cannot be activated from the 89600 VSA software. For multichannel streaming, hardware control is only available via the M9392A API interface which supports IVI COM. While streaming acquisition cannot be accomplished using the 89600 VSA software, it can be used for analysis of M9392A recordings. The 89600 VSA software provides the user a convenient way to playback previously recorded data. Both single channel and dual channel streaming records can be played back and thoroughly analyzed using this software.

Dual M9392A, dual M9392A digitizer only

For playback of dual M9392A streaming records, a 2-channel configuration will need to be made using the 89600 VSA hardware configuration tool. In order to create a dual channel configuration the engineer must first identify the hardware and then create an IVI configuration for each M9392A streaming analyzer.

Step 1. Creating an IVI configuration store entry

Create an IVI configuration store entry for each channel. When using two complete M9392A's, follow the same process outlined below for M9392A digitizer only mode, except you will select all modules required for the M9392A configuration. If using the M9392A software with digitizer only mode, create an IVI configuration store entry for each of the digitizers through the M9392A SFP. Upon launching the M9392A SFP, a dialog will appear prompting you to select your hardware. Any modules recognized by the M9392A software will appear.

The following example illustrates how to create a dual channel M9202A digitizer only configuration. For synchronized multichannel operation, you will need to designate one of your digitizers as master, and the remaining as slaves. It helps to pick a convention, such as master on left, slave 1 in the next slot to the right, slave 2 to the right of slave 1, etc. Note, 2 x full M9392A VSA's could have also been used.

1. Use the Agilent Connection Expert tool to identify the M9202A digitizer in the left-most slot.

Note the VISA Resource ID
(something like PXI17::12::0::INSTR).

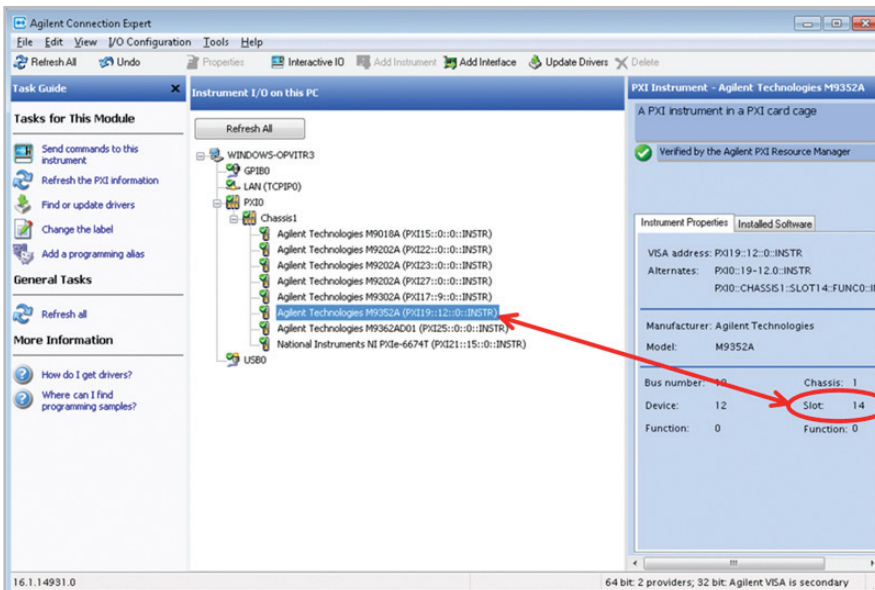

2. Next start the M9392A SFP, and choose only the M9202A digitizer with this resource ID.

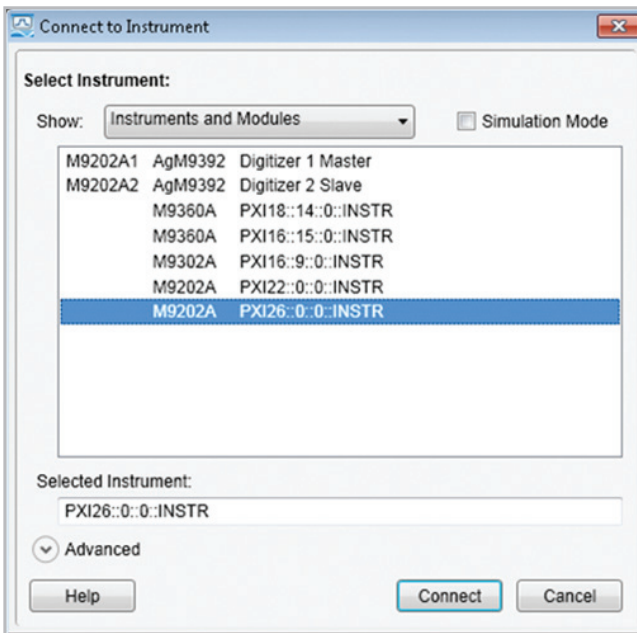

3. Press connect, and wait for hardware initialization to complete. Choose File→Save Connection.

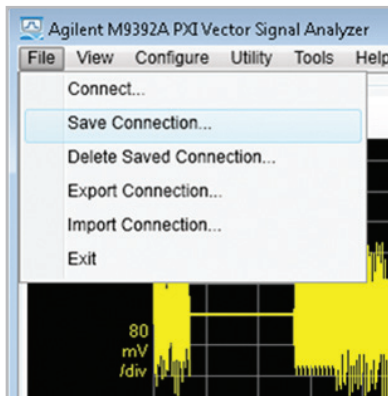

4. On the dialog that appears, give the configuration a recognizable name, avoiding spaces and underscore (_) characters. Enter a description in the description field, and be sure to check the export to Agilent 89600 VSA checkbox before pressing the save button.
5. Choose the File→Connect menu, and connect to the first slave digitizer, save a configuration for this digitizer, and repeat for all channels in your configuration.

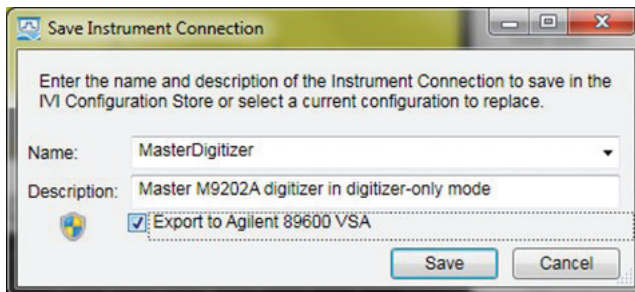

Step 2. Creating an 89600 VSA hardware configuration

Start the VSA software or restart it to rediscover hardware. This will allow it to recognize the new IVI configuration store entries that were exported in the previous step.

1. On the Utilities→Hardware dialog in the VSA software, click on the discovered instruments tab. The configurations you just added will be present in the under the TCP/IP tree element.

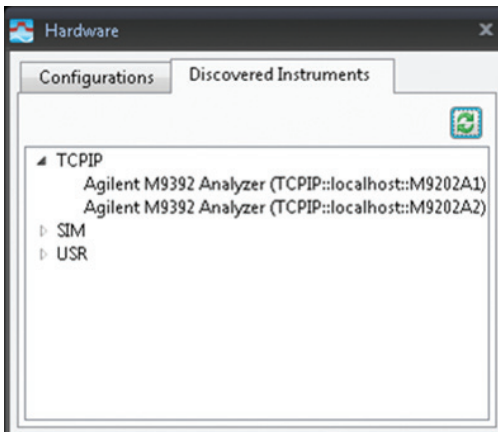

- Switch back to the configurations tab, and create a new configuration by pressing the button with the green + symbol.

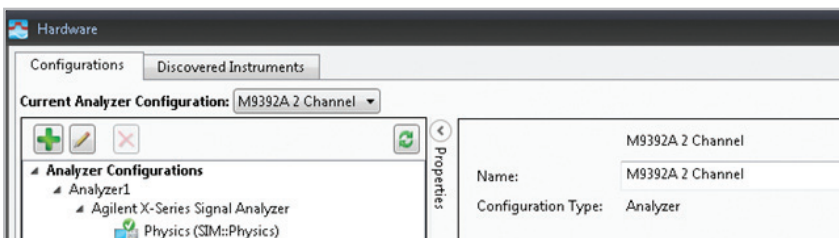

- Add one Agilent M9392A analyzer connection per channel to the configuration box by pressing the right-arrow button.
- Select the master digitizer configuration you created for the top most entry in the configuration box by choosing it from the drop-down list labeled analog to digital(ADC).
- Repeat this for the slave digitizers. It is important that the master digitizer be associated with the topmost entry for synchronized operation.
- Now you are ready to start using your hardware. Give the configuration a name and press OK.

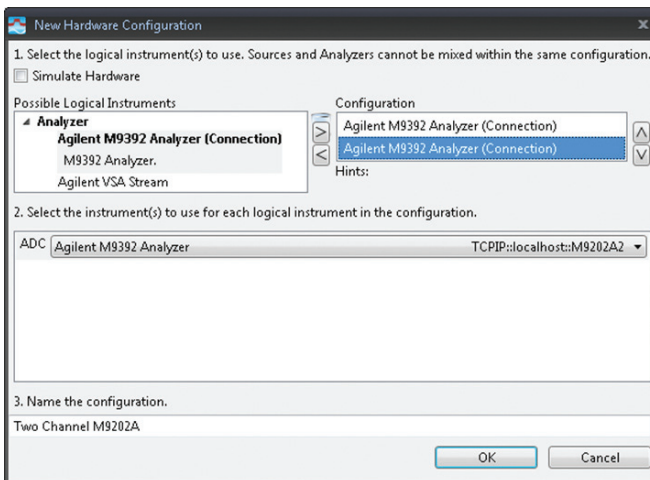

- On the hardware dialog, choose the newly created configuration from the current analyzer configuration list box and wait for the hardware to initialize.

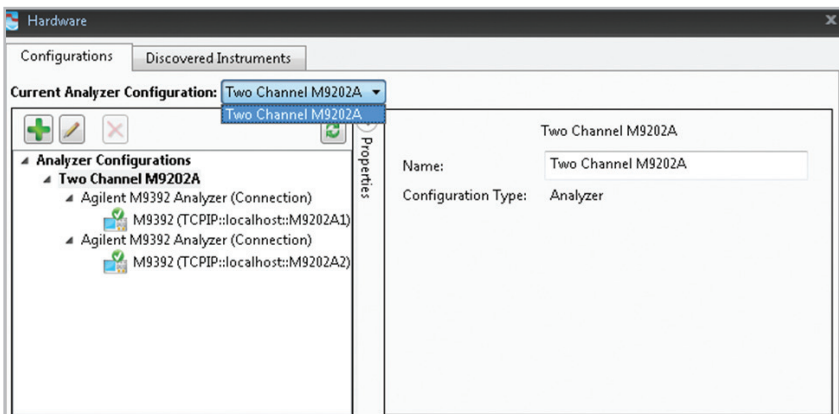

Step 3. Operation

Adjust trigger delay and channel to channel skew. Trigger delay for all channels can be adjusted by using the delay setting on the Input→Trigger dialog. To adjust the channel to channel skew between the master and all slave channels, a new parameter has been added to Input→Extensions: SlaveTriggerSkew.¹ The following goes into more detail on trigger delays and slave trigger skew.

By default, after selecting a multichannel PXI VSA hardware configuration, only one input channel will be enabled. To enable more channels, use the Input→Channels menu, or by loading a setup that is configured for multichannel.

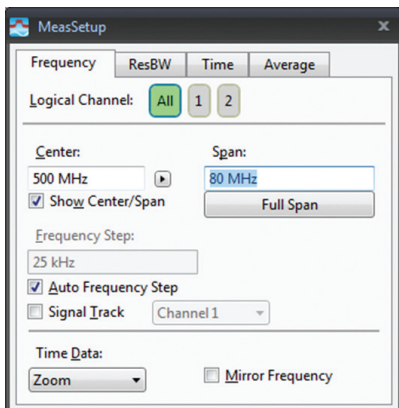
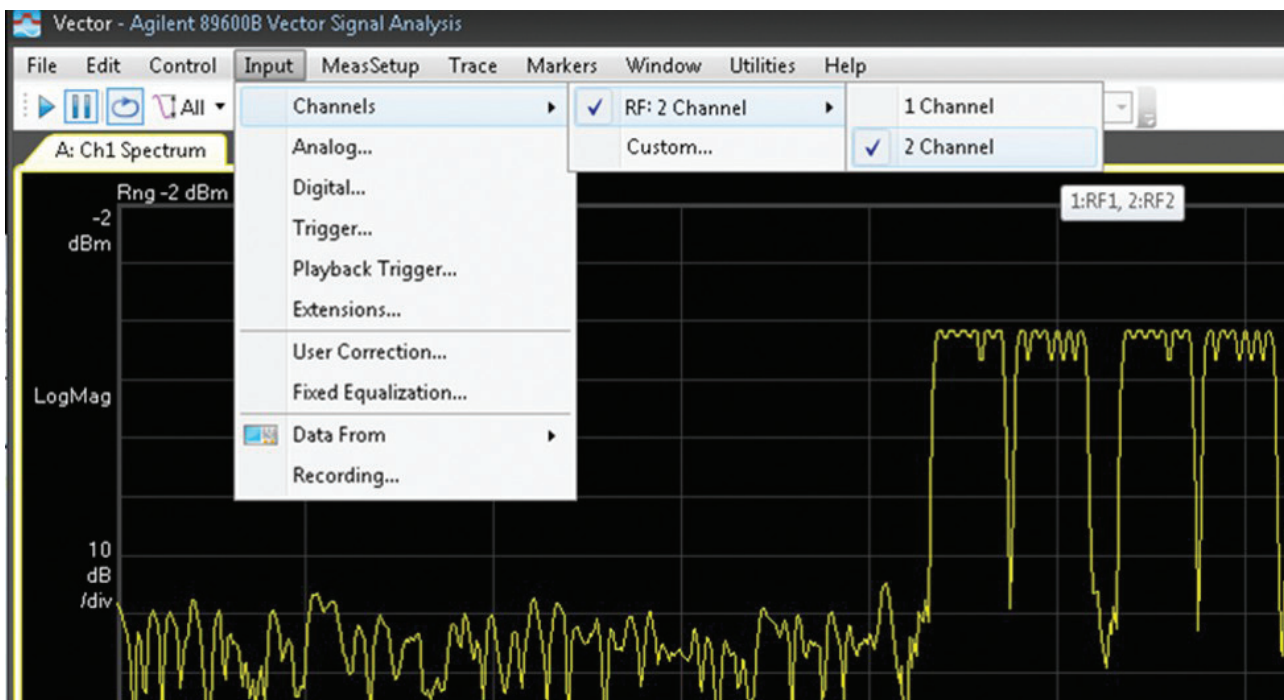

In digitizer only mode, the spectrum may be inverted, depending on whether you are using high-side or low-side LO. If you are using high-side LO, you should use the VSA software's mirror spectrum capability. Once the trigger levels and other settings are complete, you can start to make measurements. Set your center frequency to the IF center frequency (nominally 500 MHz for DDC operation), and your bandwidth. Note, with the current version 14.2 of the 89600 VSA software, the spans must be set the same value for all channels.

1. These settings only operate when connected to real hardware. The settings will not be applied when playing back a recording.

New trigger delay and slave trigger level input extensions

Trigger delay for all channels can be adjusted by using the delay setting on the Input→Trigger dialog. To adjust the channel to channel skew between the master and all slave channels, a new parameter has been added to Input→Extensions: SlaveTriggerSkew. Enter the number of seconds to move the slave trigger point relative to the master digitizer. The following illustrates this.

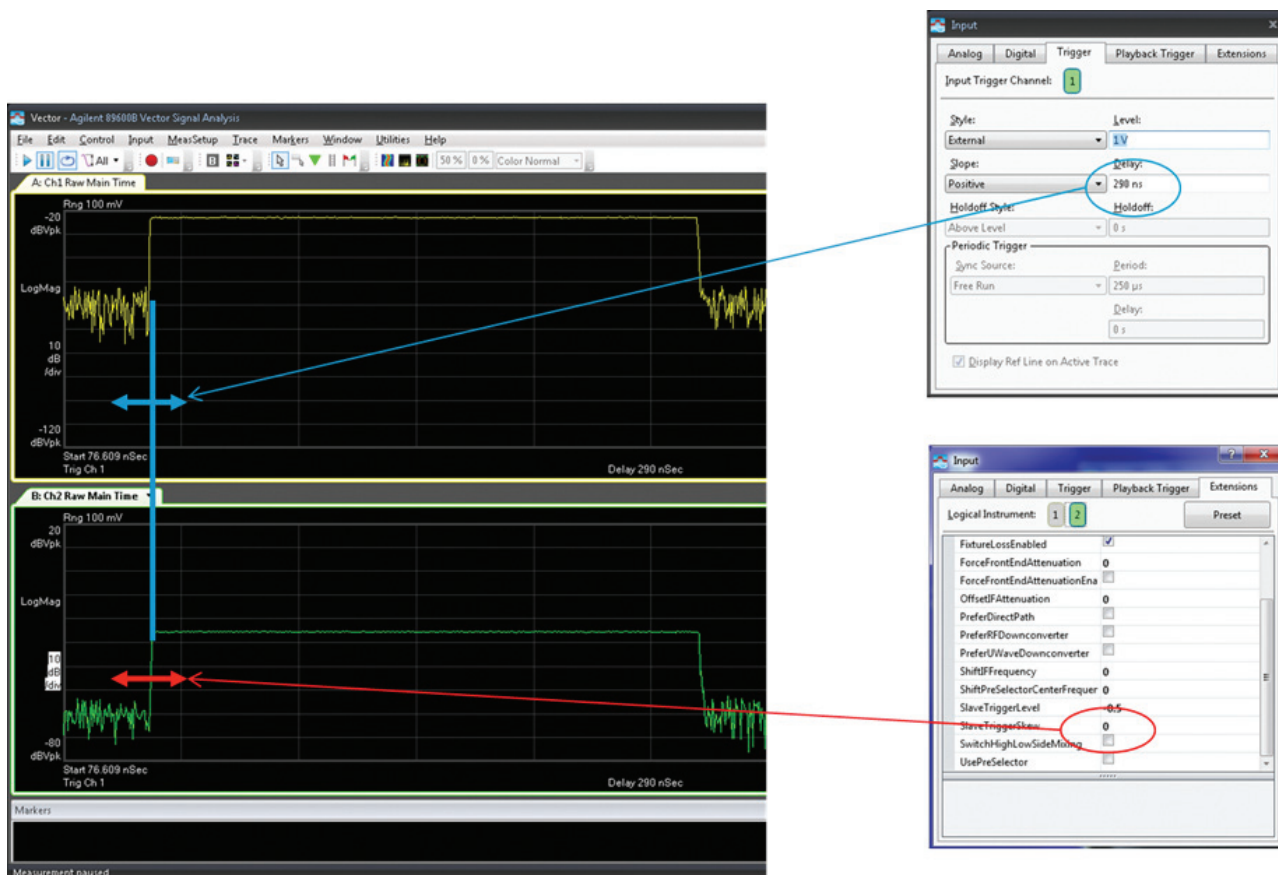

The trigger level setting on the Input→Trigger dialog will set the trigger input threshold for the master digitizer's input, either on the signal input, or on the trigger input (TRG 1 for single channel, TRG 2 for multichannel). The default slave sync trigger level will be set to -0.5 V. This is fine for dual channel streaming mode.

Playback streaming waveforms

This section describes how to load a recording into the 89600 VSA software. There are two main recording formats that are commonly used for playing back M9392A streamed data: binary format and dual channel tabulated text format

Binary format

The binary format within the 89600 VSA software is called N5110A. This is the exact same format used by the M9392A. To playback a recording, on the 89600 VSA GUI:

1. Select File→Recall→Recall Recording.

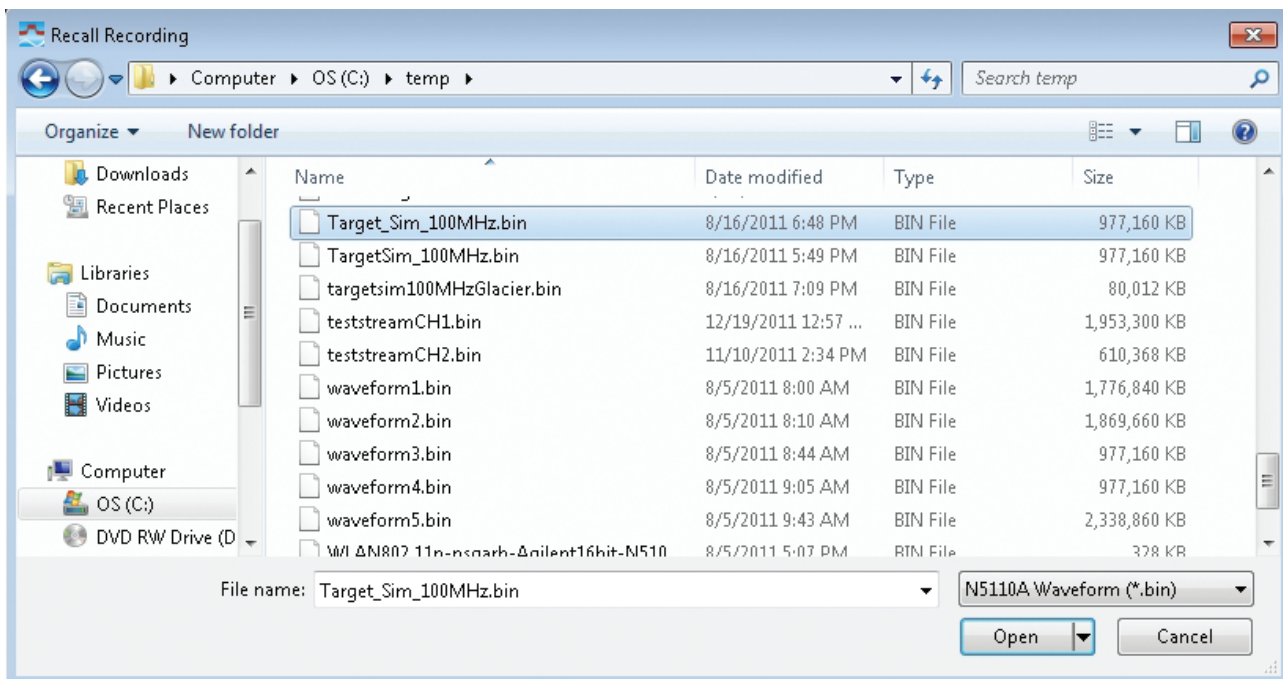

2. Browse to find an appropriate binary streaming file and then select the binary format as N5110A Waveform (*.bin), then open the file. You must have configured appropriate hardware, one or two M9392A instruments, as discussed previously. Even though the physical hardware does not need to be connected to playback the waveform, a valid IVI configuration is still required. The streaming header file will allow the 89600 VSA software to set the correct center frequency, bandwidth (span in 89600) and amplitude scaling.

Since you are manipulating a recording you need to use the playback trigger.

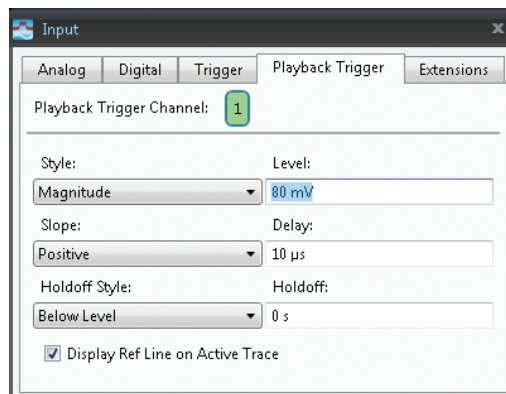

It is also useful to turn on the player bar that allows you to control the playback of the recording. In the figure below, the player is shown underneath the graph windows.



Once you are displaying useful information and are happy with your measurement, it is good practice to save the setup using File→Save→Save Setup.

The single channel binary streaming format N5110A is the most convenient for single channel measurements since it is the native format for the M9392A PXI VSA.

Playback on M9381A PXIe vector signal generator

The M9381A PXIe VSG has 4 GB of RAM which can hold 1 GSa of ARB data. At 125 Msa/s at 100 MHz bandwidth, the M9381A can collect 8 seconds of wideband signal playback. A Visual Studio based windows tool is available to load previously recorded data into an M9381A for playback. To request this tool, please contact SMS Technical Support.

7. Offsetting Digital Down Conversion (DDC) Frequencies

M9202A hardware DDC operation

The M9202A digitizer, when used with the M9392A software, takes advantage of hardware DDC in the digitizer's FPGA under certain conditions. The DDC allows for data reduction, which results in faster throughput and reduced capture sizes, which increases the maximum length of a capture by more efficiently utilizing the digitizer's memory. It also improves signal to noise ratio, resulting in improved residual error vector magnitude (EVM), among other effects.

The hardware DDC is enabled under a limited set of conditions. When the hardware DDC is not enabled, a software DDC is used instead which affords some benefits, though the digital memory efficiency is not realized since captures in this mode are stored to digitizer memory as real, full sample rate data and the software DDC is performed in the controller by the M9392A driver. Streaming does not operate under the software DDC. The table below describes the conditions under which hardware DDC is available for both complete M9392A, including simulated LO and downconverter modes, as well as digitizer only modes.

Complete M9392A and digitizer only M9392A

In this mode, hardware DDC is almost always used, as the IF center frequencies and bandwidth are chosen by the M9392A driver to ensure hardware DDC operation. The only exception is through the use of an IF offset hint. The hint usage is documented in the M9392A software, and is available through the M9392A IVI API as well as exposed in the input extensions interface in the 89600 VSA software. When an IF offset (other than 0) is used, you may encounter a mixed mode DDC, in which the following conditions apply:

- Hardware DDC decimates down to 2x the final bandwidth and sample rate
- The M9392A driver applies a frequency shift to the final IF offset
- Software DDC in the M9392A driver does a final decimation by a factor of 2

Note that pure hardware DDC may still be available under a specific set of conditions: if the entire IF span is contained between 375 and 625 MHz, and if the IF center frequency chosen is on a cardinal frequency, as defined in the following table.

Bandwidth (MHz)	Valid IF center frequency for HW DDC (MHz)
250	500
125	500
62.5	437.5, 500, 562.5 (previous row \pm 62.5)
31.25	406.25, 437.5, 468.75, 500, 531.25, 562.5, 593.75 (previous row \pm 31.25)
15.625	(previous row \pm 15.625)
Etc., 7.8125, 3.90625, 1.953125, ...	Etc. (previous row \pm bandwidth)

In the following cases, hardware DDC cannot be used:

- IF bandwidth greater than 250 MHz
- IF center frequency outside the range of 375 to 625 MHz
- IF center frequency within 375 to 625 MHz, but the IF bandwidth causes part of the IF signal to fall outside the 375 to 625 MHz range

In those cases, software DDC is used exclusively. All decimation and frequency shifting is performed by the M9392A driver.

Digitizer only mode

In digitizer only mode, it is possible for any of the three operation modes described above to occur. Because the IF center frequency is now settable directly in the 89600 VSA software or via the M9392A API, it is much more likely for either the mixed mode DDC or software DDC modes to be used. The same rules from the previous section apply, but the IF offset hint is not needed to set the IF center frequency. All other settings will either utilize mixed mode DDC or software DDC, depending on whether the IF span is fully contained within the 375-625 MHz range. Please also note the following:

- Streaming can operate only when the hardware is configured to use the hardware DDC mode.
- The 89600 VSA software is only used for playback of a recording. This means that the 89600 VSA software does not need to communicate with actual M9392A hardware. Simulated M9392A hardware will work just as well.
- IF (video) triggering only operates in pure hardware DDC mode. The M9392A driver will automatically switch to external trigger if video trigger is enabled and the digitizer is operating in mixed mode DDC or software DDC modes.
- The maximum acquisition time for a given bandwidth will be different in each of the three DDC modes.
- The nominal trigger delay may be different in each of the three DDC modes.

8. Multichannel Streaming Demonstration Example

The M9392A SFP cannot be used to make multichannel streaming measurements. This demonstration example program has been created using Microsoft Visual Studio C# 2008[®], to use the M9392A IVI COM to programmatically control a multichannel streaming session.

The demonstration example called MultiChannelStreamingExampleSolution is available with source code to allow engineers to begin making multichannel streaming measurements immediately. The source code shows which IVI COM command sequences are required and which test techniques are recommended. The solution can be built on a 32 bit operating system (OS) but a 64 bit OS is recommended.

Step 1. Download the example program

To get started, download the multichannel streaming example program. As this is a Microsoft Visual Studio C# 2008 solution, installed M9392A software must be version 1.2.0 or greater:¹

- Go to www.agilent.com/find/M9392A and click on technical support.
- Access the drivers, updates and examples tab.
- Download MultiChannelStreamingExample.zip, unzip and extract to your chosen folder
- A help file for the example can be found in <You Folder>/MultiChannelStreamingExample/MCStreamingHelp.pdf
- Build and run <Your Folder>/MultiChannelStreamingExample/MultiChannelStreamingExample.sln

¹ If you are running a different version of the software, you may need to replace the M9392A IVI reference in the example program and then rebuild the software program.

After a few seconds the program GUI will appear.

Technical Support

M9392A PXI Vector Signal Analyzer: 50 MHz to 26.5 GHz

Product Status: Currently Orderable | Currently Supported

[View Product Details](#)

Both Multichannel Streaming example programs go here.
The Multichannel Streaming Coherent Alignment Tool goes here, too.

Document Library | **Drivers, Updates & Examples** | FAQs | Training & Events

Refine the List

1-2 of 2

M9392A PXI Vector Signal Analyzer Instrument Drivers
Supported models: M9392A, M9202A, M9302A, M9351A, M9360A, M9361A, M9392A

Driver

M9392A Example Programs
Example programs for the M9392A PXI Vector Signal Analyzer. These programs are software installer. Includes sample programs in Visual Studio.net, LabVIEW, MATLAB, and VEE Pro.

Programming Example

Step 2. Configure the master and slave instruments

If you intend to run this program to control real hardware, you must first configure the master and slave instruments in the configuration store.

- Before you start, make sure you completed all software and hardware installation steps in the M9392A startup guide (<http://cp.literature.agilent.com/litweb/pdf/M9392-90001.pdf>). The configuration includes two complete M9392A VSAs in the same chassis.
- Use Agilent Connection Expert (an Agilent IO libraries suite utility) to verify the VISA address and slot number of each module. Notice that the information in the right pane is relevant to the highlighted module in the left pane.

Instrument I/O on this PC

Refresh All

WINDOWS-S2R5A7K

- GPIB0
- LAN (TCPIP0)
- PXI0
 - Chassis1
 - Agilent Technologies M9018A (PXI15:0:0::INSTR)
 - Agilent Technologies M9202A (PXI24:0:0::INSTR)**
 - Agilent Technologies M9202A (PXI9:0:0::INSTR)
 - Agilent Technologies M9302A (PXI17:15:0::INSTR)
 - Agilent Technologies M9302A (PXI19:14:0::INSTR)
 - Agilent Technologies M9351A (PXI17:9:0::INSTR)
 - Agilent Technologies M9351A (PXI19:8:0::INSTR)
 - Agilent Technologies M9360A (PXI17:13:0::INSTR)
 - Agilent Technologies M9360A (PXI19:12:0::INSTR)
 - Agilent Technologies M9361A (PXI17:10:0::INSTR)
 - Agilent Technologies M9361A (PXI19:9:0::INSTR)

USB0

PXI Instrument - Agilent Technologies M9202A

A PXI instrument in a PXI card cage

Verified by the Agilent PXI Resource Manager

Instrument Properties | Installed Software

VISA address: PXI24:0:0::INSTR

Alternates: PXI0:24-0:0::INSTR
PXI0:CHASSIS1:SLOT11:FUNC0::INST

Manufacturer: Agilent Technologies

Model: M9202A Digitizer

Bus number: 24 Chassis: 1

Device: 0 Slot: 11

Function: 0 Function: 0

- Use the M9392A Soft Front Panel (SFP) to create master and slave configurations.

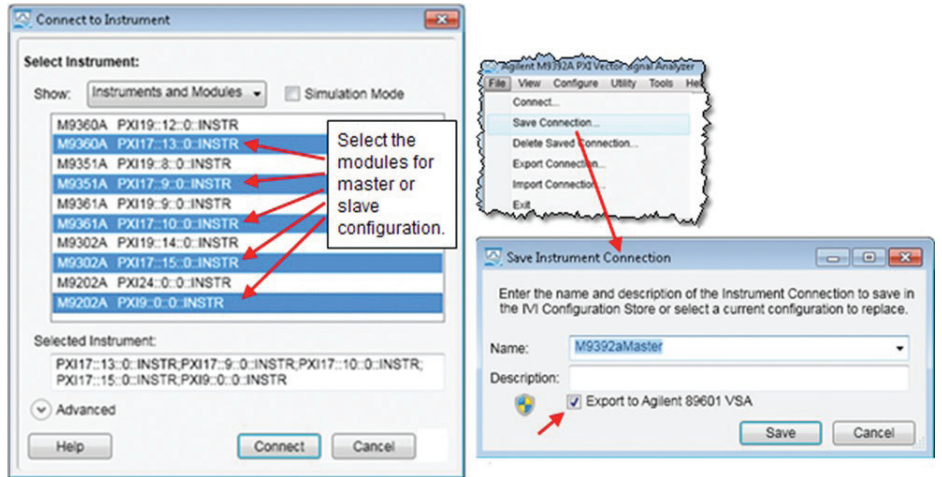

- Open the M9392A SFP.
- In the connect to instrument dialog, highlight the modules you want to save as a master, and then click connect. This initializes the master modules and opens the SFP main window.
- Select File→Save Configuration.
- In the save instrument connection dialog, type in MasterVSA, make sure the checkbox for export to Agilent 89601 VSA is checked, and then click save. You have now saved the master configuration.
- Select File→Connect.
- In the connect to instrument dialog, notice your master configuration is named. Also notice the non-master modules are highlighted. These should be the slave modules. Make sure the modules you want to save as a slave are highlighted, and then click connect. This initializes the slave modules and opens the SFP main window.
- Select File→Save Configuration.
- In the save instrument connection dialog, type in SlaveVSA, make sure the checkbox for export to Agilent 89601 VSA is checked, and then click save. You have now saved the slave configuration.

Step 3. Cable the M9392A instruments for streaming



Add the appropriate cabling kit to the two existing cabled M9392A instruments to complete the dual-channel configuration. See the M9392A configuration guide <http://cp.literature.agilent.com/litweb/pdf/5990-8254EN.pdf> for details.

Step 4. Touring the example program

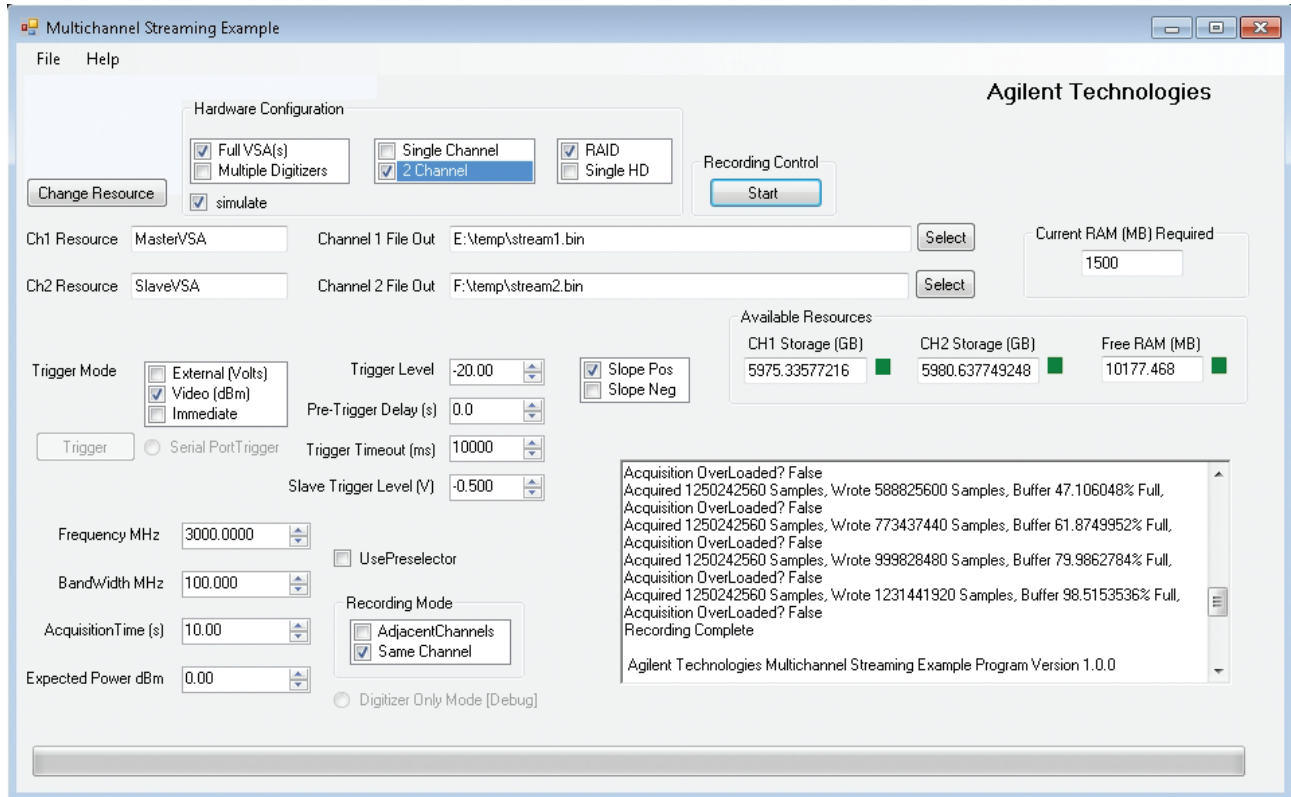
Below is a screenshot from the multichannel steaming demonstration example software.



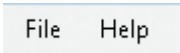
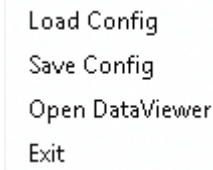
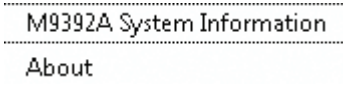

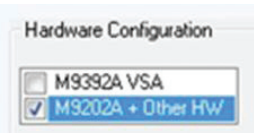
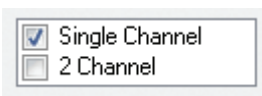
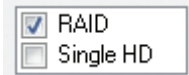

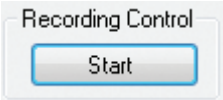

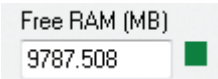
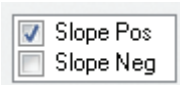
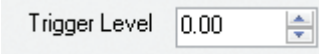
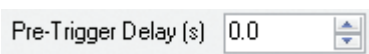
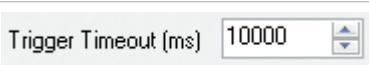
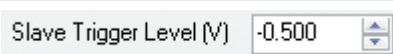
Refer to the table below for usage information about the multichannel streaming example program.

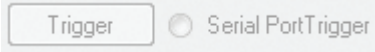
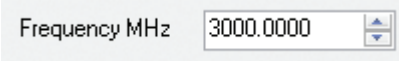
User interface item	Purpose	Description
	Program menus	Dropdown menus for File and Help
	File menu	Load Config – allows the user to load a previously saved measurement configuration. Save Config – allows the user to save a measurement configuration. Open DataViewer – opens Agilent’s free streaming data viewer. Exit – terminates the program.
	Help menu	M9392A System Information – displays the model, serial number, slot number, and the hardware revisions of all modules allocated to Ch1 resource and Ch2 resource (if two channels are selected). About – displays the current revision of the example program.
	Change IVI resource	Change Resource – configures/re-configures the resources entered into Ch1 resource and Ch2 resource (if two channels are selected).
	Select basic hardware type	M9392A VSA – provides automatic program control for one or two full M9392A instruments. M9202A + Other HW – provides automatic program control for one or two digitizer only M9392A instruments. In digitizer only mode, center frequency is set to 500 MHz and expected power is set to -4 dBm.
	Select the number of channels	Single Channel – selects the IVI resource on Ch1 resource input and instantiates a driver session. 2 Channel – selects the IVI resources in Ch1 resource and Ch2 resource and instantiates a driver session on each IVI resource.
	Select final storage	RAID – establishes connection to a viable RAID system. Since data can be written to RAID as fast as it is acquired, less RAM resources are required. Single HD – establishes connection to a single hard disk drive. This means for wide bandwidth captures for more than a few seconds large amounts of RAM will be required. Selecting Single HD allows all the free RAM to be allocated to the streaming process.

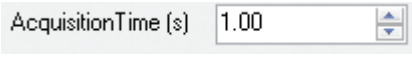
User interface item	Purpose	Description
	Start, acquisition.	In the executable only version of the code these three buttons are on a different thread so that the GUI remains active over long recordings. Start – starts an acquisition based on the measurement configuration you have set in the GUI.
<input checked="" type="checkbox"/> simulate	Configure simulation mode	The program will always start in simulation mode, basically guaranteeing the program will not crash due to bad IVI hardware configuration. Simulate – allows you to use the example program to make simulated acquisitions without having any hardware connected.
Ch1 Resource <input type="text" value="MasterVSA"/> Ch2 Resource <input type="text" value="SlaveVSA"/>	IVI hardware configurations	Ch1 Resource – is the IVI configuration used by real hardware configured as the master channel. Ch2 Resource – is the IVI configuration used by real hardware configured as the slave channel. If only one channel is selected, Ch2 will not be used.
Channel 1 File Out <input type="text" value="c:\temp\stream1.bin"/> Channel 2 File Out <input type="text" value="c:\temp\stream2.bin"/>	Set streaming file names	Channel 1 File Out – sets the destination of the output streaming file on Ch1. Channel 2 File Out – sets the destination of the output streaming file on Ch2.
<input type="button" value="Select"/> <input type="button" value="Select"/>	Select or browse or select a streaming file	Use the Select buttons to browse for previous file names, find new drives, or create new file destinations. It is possible to store each stream on a different volume. This is required when employing a dual controller JMR RAID system.
Current RAM (MB) Required <input type="text" value="1000"/>	Current RAM required	Current RAM (MB) Required – estimates the RAM required based on the current configuration settings. If RAM required is greater than Free RAM, then a streaming record cannot be made.
CH1 Storage (GB) <input type="text" value="163.996991488"/> <input checked="" type="checkbox"/> CH2 Storage (GB) <input type="text" value="163.996991488"/> <input checked="" type="checkbox"/>	Current free space on storage medium	Ch1 Storage (GB) – uses Windows® to calculate the free space on the allocated drive volume. If the space required for the current settings exceeds the available space the green box () will turn red () and the program will not allow a streaming record to be made. Ch2 Storage (GB) – uses Windows to calculate the free space on the allocated drive volume. If the space required for the current settings exceeds the available space the green box () will turn red () and the program will not allow a streaming record to be made.

User interface item	Purpose	Description
	Free system RAM	Free RAM (MB) – indicates the amount of free RAM available for streaming acquisition. If current RAM required is larger than free RAM (MB), then the green box (■) will turn red (■) and the program will not allow a streaming record to be made.
	Trigger slope	Slope Pos – sets the trigger slope to positive. Slope Neg – sets the trigger slope to negative.
	Trigger level	Trigger Level – sets the trigger level for digitizer on Ch1 (the master). If video trigger is selected, then the units are in dBm. If external trigger is selected, then the units are in volts.
	Pre-trigger delay	Pre-Trigger Delay (s) – sets the pre-trigger delay on each digitizer. If two channels are selected, pre-trigger will be applied to both channels. Pre-trigger can be no more than 75% of the current acquisition time. If acquisition time is 10 seconds and pre-trigger is set to 2 seconds, the total recording will be 10 seconds long. The first 2 seconds of the data will be pre-trigger data. Note, pre-trigger is wholly dependent on the amount of system RAM.
	Trigger timeout	Trigger Timeout (ms) – sets the amount of time an active streaming acquisition will wait for a trigger before terminating.
	Slave trigger level (two channels only)	Slave Trigger Level (V) – Only applies when two channels are selected. Sets the level of the trigger received from the master trigger out. If in external trigger mode on the master digitizer (Ch1), the master trigger out does not need to be connected to the master trig 1 input. In external trigger mode the trigger out of the master must be connected to the slave digitizer trig 1 input. For external trigger on master with two channels, set this value to between -0.5 V and -0.25 V. If in video trigger mode on the master digitizer (Ch1), the master trigger out must be connected to both master trig 1 input and slave trig 1 input. Set the slave voltage somewhere between -0.5 V and -0.25 V.

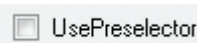
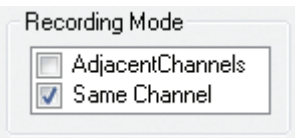
User interface item	Purpose	Description
	Trigger mode	<p>External (Volts) – sets the trigger on the master digitizer (Ch1) to external.</p> <p>Video (dBm) – sets the trigger on the master digitizer (Ch1) to video</p> <p>Immediate – triggers a streaming acquisition as soon as the hardware is ready. Note, only valid for single-channel mode. If two channels are selected, triggering will be defaulted to video trigger mode.</p>
	Serial port trigger	<p>Trigger – use this button to issue a serial port trigger at any time.</p> <p>Serial Port Trigger – if selected, the master digitizer is set to external trigger mode. Pressing the trigger button will send a trigger voltage down a serial port cable between 0 V and 5 V. <i>This feature is not available at this time.</i></p>
	Frequency	<p>Frequency MHz – sets the center frequency of the acquisition. If in multiple digitizer mode, this will set digitizer IF frequency (default 500 MHz).</p>
	Acquisition bandwidth	<p>Bandwidth MHz – sets the cardinal sample rate appropriate to this bandwidth on both channels. If bandwidth is set to 50 MHz, a sample rate of 62.5 MSa/s will be set. If bandwidth is set to 51 MHz, then the next highest cardinal sample rate is 125 MSa/s. For streaming the cardinal sample rates are 125 MSa/s, 62.5 MSa/s, 31.25 MSa/s, 15.625 MSa/s. If the bandwidth requested * 1.25 falls between any two cardinal sample rates then the highest sample rate is selected.</p>
	Acquisition time	<p>Acquisition Time (s) – requested recording time for each channel.</p>
	Expected power	<p>Expected Power dBm – sets the gain in the M9392A front end so that the digitizer is always near full scale. For proper sensitivity, you should always try to provide an accurate value for expected power. Remember with signals that have a high peak-to-average ratio (PAR or power factor), this value should be added to the CW power output of the source.</p> <p>For example, for -10 dBm source output power with a modulated signal having PAR of 10 dB, expected power should be set to approximately 0 dBm.</p>

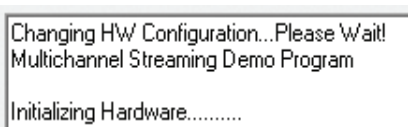
User interface item	Purpose	Description
	Use preselector	Use Preselector – turns on the M9360A preselector only if the M9392A instrument is set in highband (above 2.75 GHz) and bandwidth is set to 40 MHz or less.
	Recording mode	Useful only when two channels are selected. Adjacent Channels – Full VSA instruments used this mode will set the slave channel center frequency to frequency MHz + bandwidth MHz, thus accommodating making adjacent channel measurements. Not currently supported in for digitizer only configurations using multiple digitizers. Same Channel – sets both channels to the same center frequency (for full VSAs) or the same IF frequency (for digitizer only configurations using multiple digitizers).
	Digitizer only mode	Digitizer Only Mode (debug) – allows support to debug front-end hardware independently of digitizers. <i>This feature is not available at this time.</i>
	Progress bar	Progress Bar – provides an accurate indicator of progress. Will fill to 100% green after acquisition has completed. Note, when using simulated data, the actual simulated acquisition time can be different from the acquisition time set in the GUI.
	Update status	This window provides status information about the current configuration. It updates approximately once per second during a streaming acquisition to provide the current status of the acquisition and display any API errors.

The demo program also has a basic time stamp feature that issues a Windows® system time event when a hardware trigger is detected by the M9392A software. The format is:

Trigger time: 6/12/2012 10:34:09.7590487

This simple time stamp is accurate to less than one second, but depends on the accuracy of the PC clock.

Step 5. Leveraging the demonstration example source code

The source code for this program can be used as a basis for you to write your own control programs. This is a C# solution. If you have a copy of Visual Studio® or Visual Studio C# Express®, you can modify the program and run it. If this is not required and you have already installed Agilent M9392A software version 1.2.0.xxxx, then you can run the program executable from:

- <Your folder>/MultiChannelStreamingExample/
MultiChannelStreamingDemo/bin/<Your Processor>/Release/
MultiChannelStreamingDemo.exe
- <Your Processor> is either x64 or Itanium.

Note, this example program does not run well on a 32 bit OS. If you modify the source code, the example will not be supported by Agilent.

9. Viewing and Analyzing Streaming Data

This section addresses two primary tools for finding target data within large recordings:

- Agilent's DataViewer, available with the M9392A
- X-COM Systems' Spectro-X signal analysis software

The Agilent DataViewer installed with the M9392A software can be used to view files of any size and easily snip out small sections of a much larger file so that the signal can be analyzed more fully in the 89600 VSA software.

Please refer to the M9392A software installation package which contains extensive help information for the DataViewer.

Agilent DataViewer screenshot

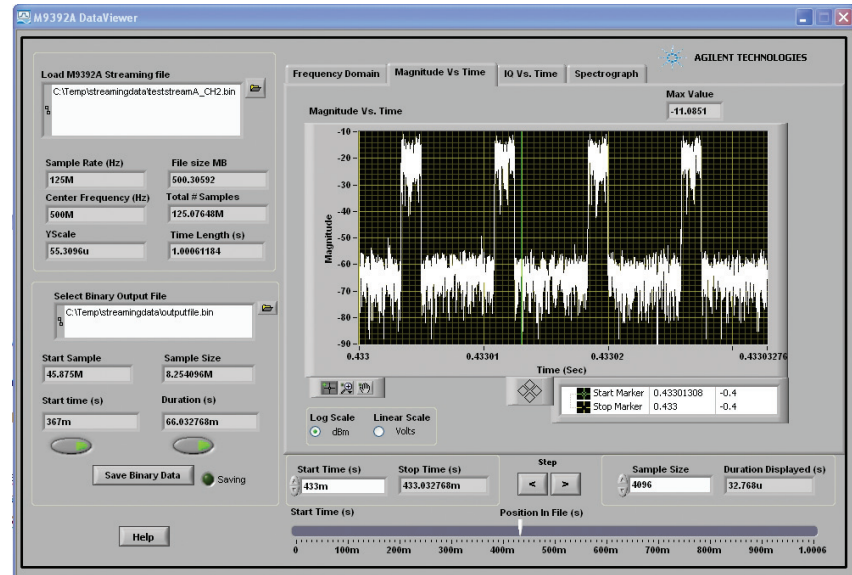

X-COM systems' Spectro-X software

The Spectro-X software has been enabled to read native binary streaming format (N5110A). Like the DataViewer it can only read a single stream of data and it can load a file of any size. A smaller subset of the main file can be snipped out for further analysis in the 89600 VSA software.

Unlike the DataViewer, Spectro-X software performs sophisticated automated searches on extremely large data sets. When the search criteria is met, a tabulated list of matching signals along with their time location within the streaming file is conveniently presented to the user.

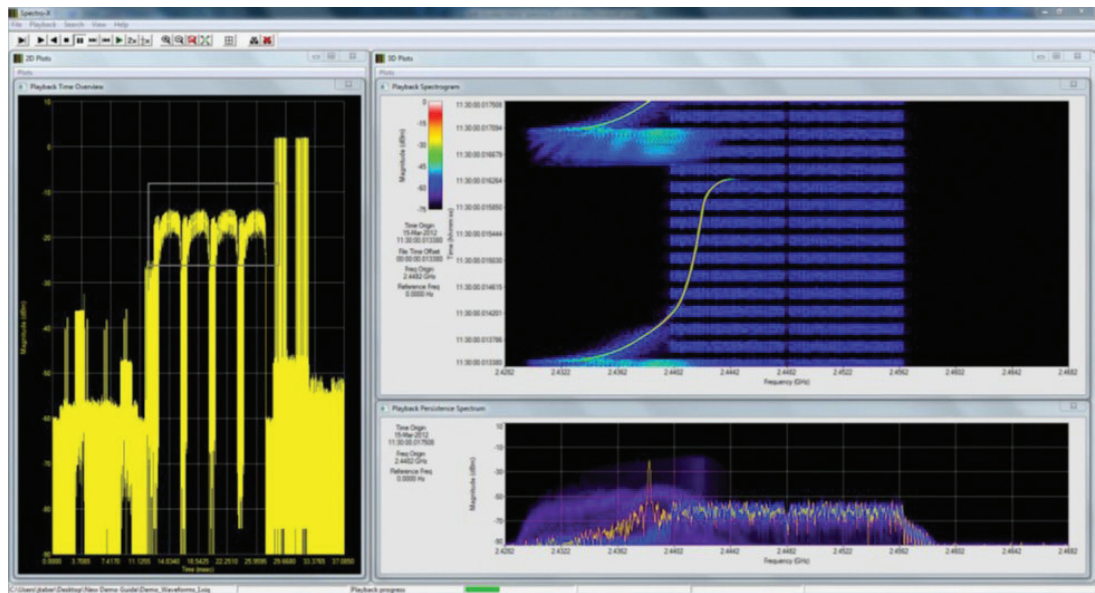

The Spectro-X software also provides a configurable spectrograph and a playback spectrum that allows the persistence time to change. This can be useful for finding and displaying transient interfering signals.

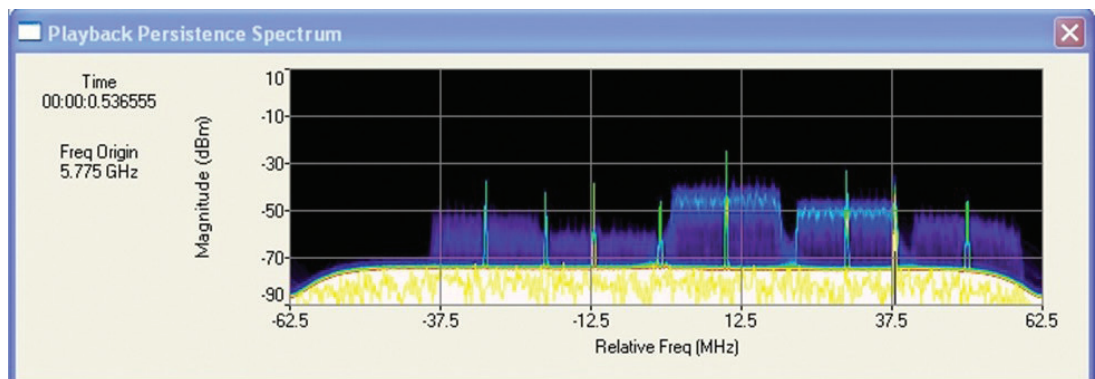

In the previous graph, an unusual intermittent waveform was found. A time signature of the waveform was acquired using the custom waveform search tool and then the signature was used to find other instances of this waveform that correlated highly to the original signature. The search uses a time domain correlation technique to find all the matching instances within the complete record.

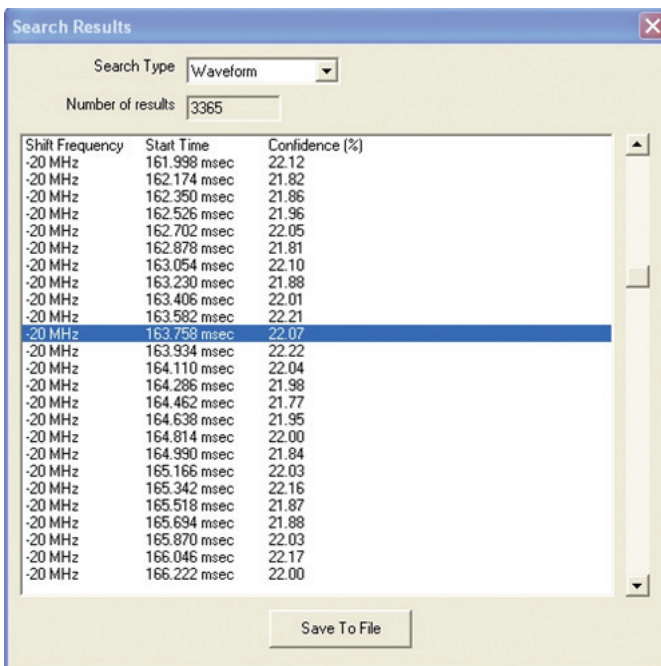

A spectrograph of any one of these items can be displayed just by selecting the item from the list above. The automatic search capability also includes commonly used communications standards such as GSM, Edge, 802.11a/g and LTE Uplink.

A spectrograph showing the interfering waveform in green is shown centered at 20 MHz from the frequency origin.

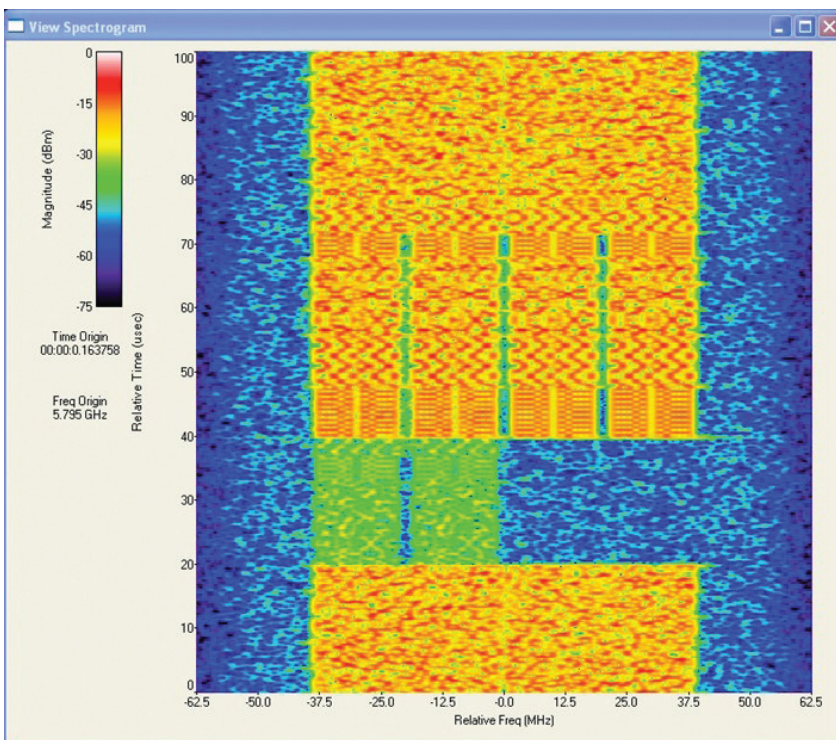

10. API Programming Instructions

The following APIs are documented with their respective products. The intent of this section is to give an overview of some of the highlights of functions needed for automating the multichannel streaming with the PXI VSA. The API is the only way to control multichannel streaming.

M9392A

The M9392A software is used to control the five PXI VSA modules. The M9392A API documentation contains examples and more details. This white paper will only cover the new commands required for control of hardware for multichannel streaming.

The following new commands are available for multichannel setups, documented in the M9392A API.

AGM9392_ATTR_CURRENT_TRIGGER_SOURCE_Attribute has two new settings. These should be used for the master digitizer when in IF magnitude or external trigger modes. The slave digitizer should be set to external trigger mode.

from AGM9392_ATTR_CURRENT_TRIGGER_SOURCE_Attribute	
AGM9392_VAL_TRIGGER_SOURCE_VIDEO_SYNC_OUT	Triggers the measurement when the video signal satisfies the constraints specified by Trigger.Video interface on a master digitizer module. The master digitizer module produces a sync pulse which must be used to trigger the master digitizer module and may be used to trigger slave digitizer modules.
AGM9392_VAL_TRIGGER_SOURCE_EXTERNAL_SYNC_OUT	Triggers the measurement when the external trigger signal satisfies the constraints specified by Trigger.External interface on a master digitizer module. The master digitizer module produces a sync pulse which may be used to trigger slave digitizer modules.

When setting up each acquisition, the slave module must be armed before the master digitizer is armed, so that when the master digitizer triggers, the slave module is ready to receive the trigger generated by the master digitizer.

AGM9392_VAL_HINT_TYPE_STREAMING_MAX_BUFFER_SIZE_IN_BYTES is a new value accessible in the hints menu that allows the user to set the upper limit for allocating buffer memory. It is critically important for multichannel streaming since each M9392A streaming session knows nothing of any other instantiated session. This means that if the engineer does not allocate a maximum number of bytes for the buffer, all of the free RAM could be used up during multichannel streaming by the first digitizer. Allocating an upper limit for the RAM buffer allows the engineer to share RAM resources for multiple digitizers. The multichannel streaming demonstration example program does this when two channels are selected.

11. Appendix

IVI COM programming

The following code, shown as Microsoft Visual Studio C#® snippets, are intended to highlight sequences of programming required or recommended for supporting multiple channel streaming measurements.

When creating streaming records that will consume a large amount of available system RAM or disk space it is always a good idea to verify that enough resources are available before beginning an acquisition.

```
//Recommended for finding Free System RAM
using System.Diagnostics.PerformanceData;
private double GetFreeMemoryMB()
{
    System.Diagnostics.PerformanceCounter ramCounter
= new System.Diagnostics.PerformanceCounter("Memory",
"Available KBytes"); //Use default RAM counter

    double _freeMemory = ramCounter.NextValue();

    _freeMemory = _freeMemory / 1e3;

    string FreeRam = Convert.ToString(_freeMemory);
    FreeMemoryMBytesTextBox.Text = FreeRam; //Update
FreeRAM textBox

    return _freeMemory;
}

//Recommended for finding Free Disk Space
using System.IO;

private double GetFreeDiskSpace(string Letter)
{
    double freeDiskSpace = 0;
    try
    {
        System.IO.DriveInfo driveInfo = new
System.IO.DriveInfo(Letter);
        freeDiskSpace = driveInfo.TotalFreeSpace;
    }
    catch (Exception ex)
    {
        UpdateStatusTextBox.Text = ex.Message.
ToString();
    }
    return freeDiskSpace; // In Bytes
}
```

This code creates a function for calculating the approximate RAM resources required for the proposed streaming acquisition. Minimal RAM resources are required with a RAID because the buffering load is light, as data is stored as quickly as it is acquired. However, pre-triggering always requires RAM even when a RAID drive is used.

When a RAID drive is not used, a larger RAM buffer is required because a single hard disk drive cannot store data faster than 100 MB/s. When pre-triggering is used, the value set is included in the acquisition time. However, the value set for pre-triggering relies on the allocation of the appropriate amount of RAM buffer (500 MB per second of capture at 100 MHz BW).

```
// Recommended
private double Calculate_Required_RAM(double dSampleRate, double dAcquisitionTime,
double PreTrigger, int iNoOfChannels)
{
    double dTotalMemReq = 0;
    if (!UsesRAID)
    {
        dTotalMemReq = (500e6 + dSampleRate * 4 * dAcquisitionTime *
iNoOfChannels); // add 500MB buffer
        dTotalMemReq = dTotalMemReq / 1e6; //MB Required
    }
    else
    {
        if (bandwidth > 20e6)
        {
            dTotalMemReq = (500e6 + dSampleRate * 4 * iNoOfChannels) +
(dSampleRate * 4 * iNoOfChannels * PreTrigger); // Add 500MB buffer / acquisition time
not important for RAID
            dTotalMemReq = dTotalMemReq / 1e6; //MB Required
        }
        else
        {
            dTotalMemReq = (250e6 + dSampleRate * 4 * iNoOfChannels) +
(dSampleRate * 4 * iNoOfChannels * PreTrigger); // Add 250MB Buffer
            dTotalMemReq = dTotalMemReq / 1e6; //MB Required
        }
    }
    string sTotalMemReq = Convert.ToString
(dTotalMemReq);
    RAMRequiredTextBox.Text = sTotalMemReq;
    //update display
    return dTotalMemReq;
}
```

Since the M9392A SFP cannot configure a synchronized 2-channel stream, the IVI API must be used. The M9392A does not automatically configure multiple channels so coupling between channels needs to be configured in the IVI COM control program.

1. The only IVI coupling between the master digitizer and the slave digitizer is through the multichannel trigger synchronization, where one digitizer is configured as the master digitizer responsible for triggering an acquisition on itself and the slave digitizer.
2. Multichannel trigger mode can only use video triggering or external triggering on the master. The slave digitizer is always set to external trigger mode because it is triggered from master trigger out.
3. The programmer must manage the free system RAM and ensure there is enough RAM available for each digitizer.
4. Since by definition, a slave digitizer can only be triggered from the master digitizer trigger out the engineer must ensure that streaming sessions always initiate streaming on the slave digitizer before the master.

The following code snippets will illustrate programming sequences that are required.

2-channel streaming code snippets

```
agDrv1 = new Agilent.AgM9392.Interop.AgM9392(); // instantiate driver
agDrv2 = new Agilent.AgM9392.Interop.AgM9392(); // instantiate driver
agDrv1.Initialize(resourceDesc1, true, true, Options); // Initialize HW
agDrv2.Initialize(resourceDesc2, true, true, Options); // Initialize HW
//Now Setup Frequency, Bandwidth Acquisition Time, Trigger Mode. Etc [Not Shown here]
//Now Setup Streaming mode and output files
agDrv1.Streaming.AcquisitionMode = AgM9392StreamingAcquisitionModeEnum.
AgM9392StreamingAcquisitionModeDurationLimited;
agDrv1.Streaming.FileFormat = AgM9392StreamingFileFormatEnum.
AgM9392StreamingFileFormatN5110A;
agDrv1.Streaming.Filename = streamFile1;
agDrv2.Streaming.AcquisitionMode = AgM9392StreamingAcquisitionModeEnum.
AgM9392StreamingAcquisitionModeDurationLimited;
agDrv2.Streaming.FileFormat = AgM9392StreamingFileFormatEnum.
AgM9392StreamingFileFormatN5110A; agDrv2.Streaming.Filename = streamFile2;
Multichannel Wideband Streaming with PXI M9392A
```



```

// Allocate maximum RAM resources to each digitizer - Use
GetFreeMemoryMB() Function to calculate FreeRAM_MB
dLockMemory = (FreeRAM_MB) / 2; //Set maximum RAM Buffer
memory per Digitizer
dLockMemory = (uint)dLockMemory;//

try
{
    agDrv1.Acquisition.
Hints.Add (AgM9392HintTypeEnum.
AgM9392HintTypeStreamingMaxBufferSizeInBytes, (long)
(dLockMemory * 1e6)); // This Hint sets an upper limit on
the RAM Buffer size -Master Digitizer
    agDrv2.Acquisition.
Hints.Add (AgM9392HintTypeEnum.
AgM9392HintTypeStreamingMaxBufferSizeInBytes, (long)
(dLockMemory * 1e6)); // This Hint sets an upper limit on
the RAM Buffer size -Slave Digitizer
}
catch (Exception ex)
{
    Err = ex.Message.ToString();
    UpdateStatus.Text = Err; //Text Box or Scrolling Rich
Text Box
}

// Setup Multichannel Master/Slave Trigger Mode
enum triggerSlope
{
    POSITIVE =
Agilent.AgM9392.Interop.AgM9392ExternalTriggerSlopeEnum.
AgM9392ExternalTriggerSlopePositive,
    NEGATIVE =
Agilent.AgM9392.Interop.AgM9392ExternalTriggerSlopeEnum.
AgM9392ExternalTriggerSlopeNegative,
}

enum triggerMode
{
    Ext = 0,
    Vid = 1,
    Imm = 2,
}

```

```

//External Trigger Example
if (triggerModeSet == Convert.ToInt16(triggerMode.Ext)) // External
{
    agDrvrl.Trigger.Source =
AgM9392TriggerSourceEnum.AgM9392TriggerSourceExternal;
    agDrvrl.Trigger.Source =
AgM9392TriggerSourceEnum.AgM9392TriggerSourceExternalSyncOut; //REQUIRED
    agDrvrl.Trigger.External.Level = TriggerLevel;
        agDrvrl.Trigger.External.Slope =
AgM9392ExternalTriggerSlopeEnum.AgM9392ExternalTriggerSlopePositive;//
REQUIRED

        if (NoOfChannels == 2)
        {
            agDrvrl2.Trigger.Source =
AgM9392TriggerSourceEnum.AgM9392TriggerSourceExternal;//REQUIRED
            agDrvrl2.Trigger.External.Level = SlaveTriggerLevel;//REQUIRED
            agDrvrl2.Trigger.External.Slope =
AgM9392ExternalTriggerSlopeEnum.AgM9392ExternalTriggerSlopePositive;//
REQUIRED
        }
        bWaitForTrigger = true;
    }

//Video Trigger Example
if (triggerModeSet == Convert.ToInt16(triggerMode.Vid)) // Vid
{
    agDrvrl.Trigger.Source =
AgM9392TriggerSourceEnum.AgM9392TriggerSourceVideo;
    agDrvrl.Trigger.Source =
AgM9392TriggerSourceEnum.AgM9392TriggerSourceVideoSyncOut;//REQUIRED
    agDrvrl.Trigger.External.Level = SlaveTriggerLevel;//REQUIRED
    agDrvrl.Trigger.External.Slope =
AgM9392ExternalTriggerSlopeEnum.AgM9392ExternalTriggerSlopePositive;//
REQUIRED
    agDrvrl.Trigger.Video.Level = TriggerLevel;//REQUIRED
    agDrvrl.Trigger.Video.Slope = AgM9392VideoTriggerSlopeEnum.
AgM9392VideoTriggerSlopePositive;//REQUIRED

        if (NoOfChannels == 2)
        {
            agDrvrl2.Trigger.Source =
AgM9392TriggerSourceEnum.AgM9392TriggerSourceExternal;//REQUIRED
            agDrvrl2.Trigger.External.Level = SlaveTriggerLevel;//REQUIRED
            agDrvrl2.Trigger.External.Slope =
AgM9392ExternalTriggerSlopeEnum.AgM9392ExternalTriggerSlopePositive;//
REQUIRED
        }

        bWaitForTrigger = true;
    }
}

```

```

// Begin Streaming on 2 Channels
agDrvr2.Measurements.Initiate(); // required for streaming
UpdateStatus.Text = "Start Streaming on Slave!\n";//Text Box or
Scrolling Rich Text Box
agDrvr2.Streaming.Start(); // required for streaming Start Slave
Digitizer First
UpdateStatus.Text = "Initiate Measurement on Master!\n";//Text Box or
Scrolling Rich Text Box

agDrvr1.Measurements.Initiate(); // required for streaming Initialize
Master Digitizer Second
UpdateStatus.Text = "Start Streaming on Master!\n"; //Text Box or
Scrolling Rich Text Box

agDrvr1.Streaming.Start(); // required for streaming

// Update Streaming status during Acquisition
// Useful Functions for Status update
private void CheckForTrigger()
{
    string Error = null;

    if (agDrvr1.Measurements.WaitForTrigger(timeOut) ==
AgM9392WaitStatusEnum.AgM9392WaitStatusComplete)
    {
        UpdateStatus.Text = "Trigger Received!\n";//
bWaitForTrigger = false;
    }
else if (agDrvr1.Measurements.WaitForTrigger(timeOut) ==
AgM9392WaitStatusEnum.AgM9392WaitStatusWaitExpired)
    {
        UpdateStatus.Text = "Trigger Timed Out!\n"; //Text Box or
Scrolling Rich Text Box

        bWaitForTrigger = false;

    try
    {
        UpdateStatus.Text = "Aborting Channel 1 Measurement!\n";//
agDrvr1.Measurements.Abort();
        UpdateStatus.Text = "Aborting Channel 2 Measurement!\n";//
agDrvr2.Measurements.Abort();
    }
    catch (Exception err)
    {
        Error = err.Message.ToString();
        UpdateStatus.Text = Error; //Text Box or Scrolling Rich Text
Box
    }
}
}

```

```

private void StreamingStatusUpdate()
{
    int NoOfErrors = agDrvrl.Status.NumberOfErrors;
    if (NoOfErrors > 0)
    {
        int errCode = 0;
        string ErrorMessage = null;
        agDrvrl.Utility.ErrorQuery(ref errCode, ref
ErrorMessage);
        string ErrorLine = null;
        ErrorLine = "\nThere Was an Error! ErrorCode:"
+ errCode + "Error Message:" + ErrorMessage +
"\n\n";
        Thread.Sleep(100);
        UpdateStatus.Text = ErrorLine; //Text Box or
Scrolling Rich Text Box
    }

    string sStatus = "Acquired" +
agDrvrl.Streaming.SamplesAcquired.ToString() +
"Samples," +
"Wrote" + agDrvrl.Streaming.SamplesWritten.
ToString() + "Samples," +
"Buffer" + ((double)
(agDrvrl.Streaming.SamplesWritten) /
(agDrvrl.Streaming.SamplesRequested) * 100).
ToString() + "% Full," +
"Acquisition OverLoaded?" +
agDrvrl.Measurements.DidAcquisitionOverload.
ToString() + "\n";

    UpdateStatus.Text = sStatus; //Text Box or
Scrolling Rich Text Box
    }
}

```

```

// Example of Streaming Status Update using useful functions
while (bWaitForTrigger)
{
    UpdateStatus.Text = "Waiting For Trigger 1...\n";//
    Text Box or Scrolling Rich Text Box

    CheckForTrigger();
}

string Error = null;

while (agDrvr1.Streaming.IsActive && !exit)
{
    try
    {
        StreamingStatusUpdate();
    }
    catch (Exception err)
    {
        Error = err.Message.ToString();
        UpdateStatis.Text = Error; //Text Box or
        Scrolling Rich Text Box
    }
    System.Threading.Thread.Sleep(1000); //
    update every second
}
UpdateStatus.Text = "Recording Complete\n";//
Text Box or Scrolling Rich Text Box

```

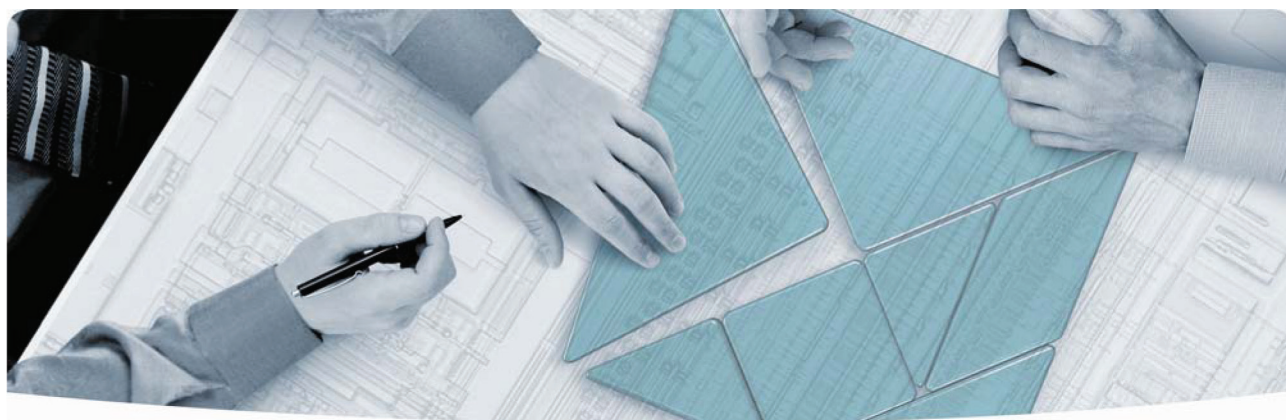

The Modular Tangram

The four-sided geometric symbol that appears in this document is called a tangram. The goal of this seven-piece puzzle is to create identifiable shapes—from simple to complex. As with a tangram, the possibilities may seem infinite as you begin to create a new test system. With a set of clearly defined elements—hardware, software—Agilent can help you create the system you need, from simple to complex



*Challenge the Boundaries of Test ...
... Agilent Modular Products*



myAgilent www.agilent.com/find/myagilent



www.pxisa.org

Agilent Solutions Partners

www.agilent.com/find/solutionspartners



Agilent Advantage Services is committed to your success throughout your equipment's lifetime.

www.agilent.com/find/advantageservices

PICMG and the PICMG logo, CompactPCI and the CompactPCI logo, AdvancedTCA and the AdvancedTCA logo are US registered trademarks of the PCI Industrial Computers Manufacturers Group. "PCIe" and "PCI EXPRESS" are registered trademarks and/or service marks of PCI-SIG. Microsoft, Windows, Visual Studio, Visual C++, Visual C#, and Visual Basic are either registered trademark or trademarks of Microsoft Corporation in the United States and/or other countries.

www.agilent.com

www.agilent.com/find/modular

www.agilent.com/find/pxi-vs-a-dualchannel

For more information on Agilent Technologies' products, applications or services, please contact your local Agilent office. The complete list is available at: www.agilent.com/find/contactus

Americas

Canada	(877) 894 4414
Brazil	(11) 4197 3600
Mexico	01800 5064 800
United States	(800) 829 4444

Asia Pacific

Australia	1 800 629 485
China	800 810 0189
Hong Kong	800 938 693
India	1 800 112 929
Japan	0120 (421) 345
Korea	080 769 0800
Malaysia	1 800 888 848
Singapore	1 800 375 8100
Taiwan	0800 047 866
Other AP Countries	(65) 375 8100

Europe & Middle East

Belgium	32 (0) 2 404 93 40
Denmark	45 45 80 12 15
Finland	358 (0) 10 855 2100
France	0825 010 700* *0.125 €/minute
Germany	49 (0) 7031 464 6333
Ireland	1890 924 204
Israel	972-3-9288-504/544
Italy	39 02 92 60 8484
Netherlands	31 (0) 20 547 2111
Spain	34 (91) 631 3300
Sweden	0200-88 22 55
United Kingdom	44 (0) 118 927 6201

For other unlisted countries: www.agilent.com/find/contactus

Revised: October 11., 2012

Product specifications and descriptions in this document subject to change without notice.

© Agilent Technologies, Inc., 2012
Published in USA, November 13, 2012
White Paper 5991-0221EN



Agilent Technologies